



SUDEXPRESS[®]
scale model trains

Novelties | Neuheiten | Novidades | Novedades | Nouveautés

2025-2026





SCHINDLER WAGONS S.A., PRATELN-SUIÇA

Carruagens normais e de luxo, construção ligera em aço para caminhos de ferro.
Wagons de mercadorias de todos os tipos. Automotores e carruagens para tramsways.



SUDEXPRESS
scale model trains

H0 1:87



SUDEXPRESS
scale model trains

EURODUAL
STADLER

H0 1:87



MEDWAY





About Sudexpress

Sudexpress scale model trains emerges in 2008 as an extension of NORBRASS in the area of railway modeling, in plastic. Its main goal is the production of high quality models, available to a wider market. The manufacture of these models uses the latest technologies in drawing and injection molding processes, in accordance with the philosophy of precision and quality characteristic of NORBRASS.

Its name derives from the famous train Sud-Express which connects the french capital Paris to Lisbon through Madrid, since 1887.

To meet the desires of the wide variety of railway modelers, Sudexpress scale model trains presents three lines of products - Standard, Premium line and Norbrass line. As the name suggests, Standard line stands for assembled and ready to roll models with great detail and at an affordable price. Premium Line offers standard models but with extra features such as sound decoder, servo motors and other extras from factory. Norbrass line are hybrid limited edition models made in brass and plastic, combining the best of both worlds.

Sudexpress scale model trains is a trademark of Avaliare Engenharia Lda.

Über Sudexpress

Sudexpress Scale Model Trains entsteht 2008 als Erweiterung von NORBRASS Messing Modelle im Bereich Eisenbahnmodellbau in Kunststoff. Ihr Hauptziel ist die Herstellung hochwertiger Modelle, die einem breiteren Markt zur Verfügung stehen. Bei der Herstellung dieser Modelle werden modernste Technologien wie 3D CAD und Spritzgussverfahren eingesetzt, entsprechend der Präzisions- und Qualitätsphilosophie von NORBRASS.

Sein Name leitet sich von dem berühmten Zug Sud-Express ab, der seit 1887 die französische Hauptstadt Paris über Madrid mit Lissabon verbindet.

Um den Wünschen der unterschiedlichsten Eisenbahnmodellbauer gerecht zu werden, präsentiert Sudexpress Scale Model Trains drei Produktlinien - Standard, Premium Line und Norbrass Line. Wie der Name schon vermuten lässt, steht die Standard-Linie für montierte und fahrfertige Modelle mit viel Liebe zum Detail und zu einem erschwinglichen Preis. Premium Line bietet Standardmodelle, jedoch mit zusätzlichen Funktionen wie Sounddecoder, Servomotoren und anderen Extras ab Werk. Die Norbrass-Linie sind Hybridmodelle in limitierter Auflage aus Messing und Kunststoff, die das Beste aus beiden Welten vereinen.

Sudexpress Scale Model Trains ist eine Marke von Avaliare Engenharia Lda.

Sobre a Sudexpress

A Sudexpress scale model trains surgiu em 2008 como uma extensão da NORBRASS no segmento de modelos ferroviários em plástico e tem como objetivo principal a produção de modelos de grande qualidade, acessíveis a um mercado mais alargado. Na execução desses modelos são utilizadas as últimas tecnologias de desenho e injeção, seguindo uma filosofia de rigor e qualidade que caracteriza a NORBRASS.

O seu nome vem do famoso comboio Sud-Expresso que ligou a capital francesa Paris a Madrid e Lisboa, a partir de 1887.

Para ir de encontro aos desejos de uma gama ampla de modelistas ferroviários a Sudexpress scale model trains apresenta três linhas de produtos - Standard, Premium line e Norbrass line. Tal como nome indica, a linha Standard apresenta modelos já montados e prontos a rolar com um bom grau de detalhagem e a um preço acessível. A Premium Line propõem modelos standard mas com funcionalidades extra tal como decoder de som, servo-motores e luzes adicionais de fábrica. Na Norbrass Line representa modelos de alta gama híbridos, combinando latão com plástico em edições exclusivas e muito limitadas.

A Sudexpress scale model trains é uma marca registada de Avaliare Engenharia Lda.

Contents | Inhalt | Índice

H0 Locos Loks Loc.	4
EuroDual	6
Euro9000	26
Euro6000	33
Euro4001	41
Euro4000	44
ML 440/500	48
CP 1400	54
CP 2500/2550	58
H0 Rail cars Triebwagen Automotoras	62
Stadler FLIRT3	62
CP Nohab	64
H0 Passenger coaches Personenwagen Carr.	66
Carr. Sorefame	68
Furg. Sorefame	72
Carr. Schindler	75
H0 Freight wagons Güterwagen Vagões	84
Laaers	86
Tanpps	91
Zacns	94
Sggrrs 80'	99
Sggmrrs 90'	104
Sgnss 60'	116
Tgpps	120
Gbkks	122
Ealos	124
Sgmms	124
Sgs	124
Kbs	132
Zaes	133
N Locos Loks Loc.	136
EuroDual	138
Euro9000	145
Euro6000	149
Euro4000	153
N Freight wagons Güterwagen Vagões	156
Sggmrrs 90'	158
TT Locos Loks Loc.	164
EuroDual	166
Euro9000	170
TT Freight wagons Güterwagen Vagões	174
Zacns	176
Sggmrrs 90'	181
Accessories Zubehor Acessórios	186
H0 Containers and Swap Bodies	186
LED Lighting	189
Loco & car accessories	190

H0 1:87

LOCOMOTIVAS
LOCOMOTIVES
LOKOMOTIVEN







EuroDual Locomotive 2159 257-5



In cooperation with | In Kooperation mit: - Rail Force One
- Railcolor Design

Ep.	VI
266	
NEM660	21MTG
FAN MOTOR	
PowerPack	



Q4 2025

© Michael Goll

S1592578	~	🔊	🚂	- AC with Sound + Panto (Premium line version)
S1592571	DC	=		- DC analogic version
S1592570	=	🔊	🚂	- DC with Sound + Panto (Premium line version)

EuroDual Locomotive 2159 264-1



In cooperation with | In Kooperation mit: - Rail Cargo Group
- Trispel rail-de-sign

Ep.	VI
266	
NEM660	21MTG
FAN MOTOR	
PowerPack	



Q4 2025

© André Regenspürger

S1592648	~	🔊	🚂	- AC with Sound + Panto (Premium line version)
S1592641	DC	=		- DC analogic version
S1592640	=	🔊	🚂	- DC with Sound + Panto (Premium line version)

EuroDual Locomotive 2159 259-1



In cooperation with | In Kooperation mit: - LTE Logistik- und Transport GmbH
- LTE Group Design

Ep. VI
266
NEM680 21MTC
FAN MOTOR
PowerPack



© Mike Dam

Q4 2025

- S1592598 - AC with Sound + Panto (Premium line version)
- S1592591 - DC analogic version
- S1592590 - DC with Sound + Panto (Premium line version)

EuroDual Locomotive 159 005-6



In cooperation with | In Kooperation mit: - OnRail Scandinavia
- Railcolor Design

In partnership with | Partnerskap med:



Ep. VI
266
NEM680 21MTC
FAN MOTOR
PowerPack



© Richard Latten

Q4 2025

- S1590058 - AC with Sound + Panto (Premium line version)
- S1590051 - DC analogic version
- S1590050 - DC with Sound + Panto (Premium line version)



EuroDual Locomotive 2159 265-8



In cooperation with | In Kooperation mit: - Verkehrsbetriebe Peine-Salzgitter
- Railcolor Design

Ep.	VI
🔌	266
⋯	NEM680 21MTC
🌀	FAN MOTOR
🔋	PowerPack



Q4 2025

© Sebastian Bollmann

S1592658	~ 🗣️		- AC with Sound + Panto (Premium line version)
S1592651	DC =		- DC analogic version
S1592650	= 🗣️		- DC with Sound + Panto (Premium line version)

EuroDual Locomotive 2159 253-4



In cooperation with | In Kooperation mit: - Flex Bahndienstleistungen GmbH
- Railcolor Design

Ep.	VI
🔌	266
⋯	NEM680 21MTC
🌀	FAN MOTOR
🔋	PowerPack



Q4 2025

© André Regenspürger

S1592538	~ 🗣️		- AC with Sound + Panto (Premium line version)
S1592531	DC =		- DC analogic version
S1592530	= 🗣️		- DC with Sound + Panto (Premium line version)

EuroDual Locomotive 159 447-2



In cooperation with | In Kooperation mit: - Nordic Rail Service GmbH

Ep.	VI
	266
	NEM660 21MTG
	FAN MOTOR
	PowerPack



Q4 2025

© André Regenspurger

S1594478				- AC with Sound + Panto (Premium line version)
S1594471	DC	=		- DC analogic version
S1594470	=			- DC with Sound + Panto (Premium line version)

EuroDual Locomotive 2159 261-7



In cooperation with | In Kooperation mit: - Netzwerkbahn Sachsen GmbH
- Railcolor Design

Ep.	VI
	266
	NEM660 21MTG
	FAN MOTOR
	PowerPack



Q4 2025

© NeS

S1592618				- AC with Sound + Panto (Premium line version)
S1592611	DC	=		- DC analogic version
S1592610	=			- DC with Sound + Panto (Premium line version)



EuroDual Locomotive 2159 013-2



In cooperation with | In Kooperation mit: - Havelländische Eisenbahn AG

Ep.	VI
266	
NEM660	21MTC
FAN MOTOR	
PowerPack	



© Nils Metzger

Q4 2025

- | | | | | |
|-----------------|----|---|---|--|
| S1590138 | ~ | 🔊 | 🚂 | - AC with Sound + Panto (Premium line version) |
| S1590131 | DC | = | | - DC analogic version |
| S1590130 | = | 🔊 | 🚂 | - DC with Sound + Panto (Premium line version) |



© Sebastian Bollmann

NEW

EuroDual Locomotive 159 444-9



In cooperation with | In kooperasjon mit: - Raildox GmbH & Co. KG

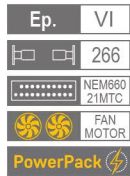

Q2 2025

S1594449	AC ~	- AC digital version
S1594448	~ 🔊 🚧	- AC with Sound + Panto (Premium version)
S1594441	DC =	- DC analogic version
S1594440	= 🔊 🚧	- DC with Sound + Panto (Premium version)

EuroDual Locomotive ED 9004



In cooperation with | I samarbeide med: - CargoNet

In partnership with | Partnerskap med:

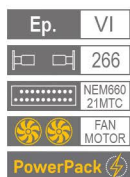

Q2 2025

SED90049	AC ~	- AC digital version
SED90048	~ 🔊 🚧	- AC with Sound + Panto (Premium version)
SED90041	DC =	- DC analogic version
SED90040	= 🔊 🚧	- DC with Sound + Panto (Premium version)



EuroDual Locomotive 159 230-2



In cooperation with | In Kooperation mit: - BBL LOGISTIK GmbH

Ep.	VI
	266
	NEM660 21MTC
	FAN MOTOR
	PowerPack



Q2 2025

S1592309	AC ~	- AC digital version
S1592308	~	- AC with Sound + Panto (Premium version)
S1592301	DC =	- DC analogic version
S1592300	=	- DC with Sound + Panto (Premium version)

EuroDual Locomotive 159 229-4



In cooperation with | In Kooperation mit: - Eisenbahnen und Verkehrsbetriebe Elbe-Weser GmbH
- Trispel rail-de-sign

Ep.	VI
	266
	NEM660 21MTC
	FAN MOTOR
	PowerPack



Q2 2025

Photomonge

S1592299	AC ~	- AC digital version
S1592298	~	- AC with Sound + Panto (Premium version)
S1592291	DC =	- DC analogic version
S1592290	=	- DC with Sound + Panto (Premium version)

EuroDual Locomotive 159 244-3



In cooperation with | In Kooperation mit: - Havelländische Eisenbahn AG

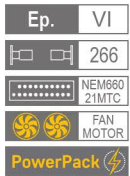

Q2 2025

S1592449	AC ~	- AC digital version
S1592448	~ 🔊 🚧	- AC with Sound + Panto (Premium version)
S1592441	DC =	- DC analogic version
S1592440	= 🔊 🚧	- DC with Sound + Panto (Premium version)

EuroDual Locomotive 159 232-8



In cooperation with | In Kooperation mit: - InfraLeuna GmbH

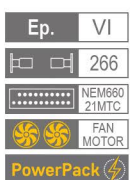

Q2 2025

S1592329	AC ~	- AC digital version
S1592328	~ 🔊 🚧	- AC with Sound + Panto (Premium version)
S1592321	DC =	- DC analogic version
S1592320	= 🔊 🚧	- DC with Sound + Panto (Premium version)



EuroDual Locomotive 159 237-7



In cooperation with | In Kooperation mit: - HHPI Heavy Haul Power International GmbH

- Ep. VI
- 266
- NEM660 21MTC
- FAN MOTOR
- PowerPack



Q2 2025

- | | | |
|----------|-------|---|
| S1592379 | AC ~ | - AC digital version |
| S1592378 | ~ 🔊 🚧 | - AC with Sound + Panto (Premium version) |
| S1592371 | DC = | - DC analogic version |
| S1592370 | = 🔊 🚧 | - DC with Sound + Panto (Premium version) |

EuroDual Locomotive 159 236-9



In cooperation with | In Kooperation mit: - Schwebbau Logistik GmbH

- Ep. VI
- 266
- NEM660 21MTC
- FAN MOTOR
- PowerPack



Q2 2025

- | | | |
|----------|-------|---|
| S1592369 | AC ~ | - AC digital version |
| S1592368 | ~ 🔊 🚧 | - AC with Sound + Panto (Premium version) |
| S1592361 | DC = | - DC analogic version |
| S1592360 | = 🔊 🚧 | - DC with Sound + Panto (Premium version) |

NEW

LOCOMOTIVES
H0

EuroDual Locomotive 159 451-4



In cooperation with | In Kooperation mit: - Erfurter Bahnservice GmbH
- Railcolor Design and OnTrack



Ep.	VI
	266
	NEM600 21MTC
	FAN MOTOR
	PowerPack



Q2 2025

S1599999	AC		- AC digital version
S1599998			- AC with Sound + Panto (Premium line version)
S1599991	DC	=	- DC analogic version
S1599990	=		- DC with Sound + Panto (Premium line version)



Die erste **Sudexpress-Werbelok** rollt schon auf den Gleisen!
Glückauf und gute Fahrt für Erfurter Bahn Service 159 451-4!

The first **Sudexpress advertising locomotive** is already rolling on the tracks!
Good luck and safe travels for Erfurter Bahn Service 159 451-4!

© Cordel Schwella



EuroDual Locomotive 159 001-7



In cooperation with | In Kooperation mit: - Havelländische Eisenbahn AG

Ep.	VI
	266
	NEM660 21MTC
	FAN MOTOR



S1590019	AC	- AC digital version
S1590018		- AC with Sound + Panto (Premium line version)
S1590011	DC =	- DC analogic version
S1590010	=	- DC with Sound + Panto (Premium line version)

EuroDual Locomotive 159 003-3



In cooperation with | In Kooperation mit: - Havelländische Eisenbahn AG

Ep.	VI
	266
	NEM660 21MTC
	FAN MOTOR



S1590039	AC	- AC digital version
S1590038		- AC with Sound + Panto (Premium line version)
S1590031	DC =	- DC analogic version
S1590030	=	- DC with Sound + Panto (Premium line version)

EuroDual Locomotive 159 208-8



In cooperation with | In Kooperation mit: - BSAS Eisenbahnverkehrs GmbH & Co. KG
- M.A.D. Logistik GmbH
- Gudrun Geiblinger Design

Ep.	VI
	266
	NEM660 21MTC
	FAN MOTOR



S1592089	AC		- AC digital version
S1592088			- AC with Sound + Panto (Premium line version)
S1592081	DC	=	- DC analogic version
S1592080	=		- DC with Sound + Panto (Premium line version)

Design by Gudrun Geiblinger

EuroDual Locomotive 159 101-5



In cooperation with | In Kooperation mit: ITL Eisenbahngesellschaft - Captrain Deutschland GmbH

Ep.	VI
	266
	NEM660 21MTC
	FAN MOTOR



S1591019	AC		- AC digital version
S1591018			- AC with Sound + Panto (Premium line version)
S1591011	DC	=	- DC analogic version
S1591010	=		- DC with Sound + Panto (Premium line version)



EuroDual Locomotive 159 201-3



In cooperation with | In kooperasjon mit: - Heavy Haul Power International GmbH

Ep.	VI
	266
	NEM660 21MTC
	FAN MOTOR



S1592019	AC		- AC digital version
S1592018			- AC with Sound + Panto (Premium line version)
S1592011	DC	=	- DC analogic version
S1592010	=		- DC with Sound + Panto (Premium line version)

EuroDual Locomotive 159 227-8



In cooperation with | I samarbeide med: - Erfurter Bahnservice GmbH
- Railcolor Design

In partnership with | Partnerskap med:



Ep.	VI
	266
	NEM660 21MTC
	FAN MOTOR



S1592279	AC		- AC digital version
S1592278			- AC with Sound + Panto (Premium line version)
S1592271	DC	=	- DC analogic version
S1592270	=		- DC with Sound + Panto (Premium line version)

EuroDual Locomotive 159 207-0



In cooperation with | In Kooperation mit: - European Locomotive Pool AG

Ep.	VI
	266
	NEM660 21MTC
	FAN MOTOR



S1592079	AC		- AC digital version
S1592078			- AC with Sound + Panto (Premium line version)
S1592071	DC	=	- DC analogic version
S1592070	=		- DC with Sound + Panto (Premium line version)

EuroDual Locomotive 159 240-1



In cooperation with | In Kooperation mit: - DB Cargo AG
- Trispel rail-de-sign

Ep.	VI
	266
	NEM660 21MTC
	FAN MOTOR



S1592409	AC		- AC digital version
S1592408			- AC with Sound + Panto (Premium line version)
S1592401	DC	=	- DC analogic version
S1592400	=		- DC with Sound + Panto (Premium line version)



EuroDual Locomotive 159 210-4



In cooperation with | In Kooperation mit: - BSAS EisenbahnVerkehrs GmbH & Co. KG
- M.A.D. Logistik GmbH
- Gudrun Geiblinger Design

Ep.	VI
	266
	NEM660 21MTG
	FAN MOTOR



S1592109	AC		- AC digital version
S1592108			- AC with Sound + Panto (Premium line version)
S1592101	DC	=	- DC analogic version
S1592100	=		- DC with Sound + Panto (Premium line version)

Design by Gudrun Geiblinger

EuroDual Locomotive 159 209-6



In cooperation with | In Kooperation mit: - BSAS EisenbahnVerkehrs GmbH & Co. KG
- M.A.D. Logistik GmbH
- Gudrun Geiblinger Design

Ep.	VI
	266
	NEM660 21MTG
	FAN MOTOR



S1592099	AC		- AC digital version
S1592098			- AC with Sound + Panto (Premium line version)
S1592091	DC	=	- DC analogic version
S1592090	=		- DC with Sound + Panto (Premium line version)

Design by Gudrun Geiblinger

EuroDual Locomotive 159 231-0



In cooperation with | In Kooperation mit: - Eisenbahnen und Verkehrsbetriebe Elbe-Weser GmbH
- Trispel rail-de-sign

Ep.	VI
	266
	NEM660 21MTC
	FAN MOTOR



S1592319	AC		- AC digital version
S1592318			- AC with Sound + Panto (Premium line version)
S1592311	DC		- DC analogic version
S1592310			- DC with Sound + Panto (Premium line version)

EuroDual Locomotive 159 212-0



In cooperation with | In Kooperation mit: - STARKENBERGER GRUPPE

Ep.	VI
	266
	NEM660 21MTC
	FAN MOTOR



S1592129	AC		- AC digital version
S1592128			- AC with Sound + Panto (Premium line version)
S1592121	DC		- DC analogic version
S1592120			- DC with Sound + Panto (Premium line version)



EuroDual Locomotive 159 221-1



In cooperation with | In kooperasjon mit: - VTG Retrack
- Trispel rail-de-sign

Ep.	VI
	266
	NEM660 21MTG
	FAN MOTOR



S1592219	AC	~	- AC digital version
S1592218	~		- AC with Sound + Panto (Premium line version)
S1592211	DC	=	- DC analogic version
S1592210	=		- DC with Sound + Panto (Premium line version)

EuroDual Locomotive ED 9002



In cooperation with | I samarbete med: - Green Cargo AB
- NMJ- Norsk Modelljernbane is Scandinavia

In partnership with | Partnerskap med:



Ep.	VI
	266
	NEM660 21MTG
	FAN MOTOR



SED90029	AC	~	- AC digital version
SED90028	~		- AC with Sound + Panto (Premium line version)
SED90021	DC	=	- DC analogic version
SED90020	=		- DC with Sound + Panto (Premium line version)

EuroDual Locomotive 159 216-1



In cooperation with | In Kooperation mit: - Holzlogistik und Güterbahn GmbH
- Trispetl rail-de-sign

Ep.	VI
	266
	NEM660 21MTC
	FAN MOTOR



S1592169	AC		- AC digital version
S1592168			- AC with Sound + Panto (Premium line version)
S1592161	DC	=	- DC analogic version
S1592160	=		- DC with Sound + Panto (Premium line version)

EuroDual Locomotive 159 217-9



In cooperation with | In Zusammenarbeit mit: - Mitteldeutsche Eisenbahn GmbH
- Trispetl rail-de-sign

Ep.	VI
	266
	NEM660 21MTC
	FAN MOTOR



S1592179	AC		- AC digital version
S1592178			- AC with Sound + Panto (Premium line version)
S1592171	DC	=	- DC analogic version
S1592170	=		- DC with Sound + Panto (Premium line version)



EuroDual Locomotive 159 214-6



In cooperation with | In Kooperation mit: - ecco-rail GmbH

Ep.	VI
	266
	NEM660 21MTC
	FAN MOTOR



S1592149	AC		- AC digital version
S1592148			- AC with Sound + Panto (Premium line version)
S1592141	DC	=	- DC analogic version
S1592140	=		- DC with Sound + Panto (Premium line version)

EuroDual Locomotive 159 238-5



In cooperation with | In Kooperation mit: - BELog Baustoffe- Entsorgung-Logistik GmbH & Co. KG
- Merco-MTW

Ep.	VI
	266
	NEM660 21MTC
	FAN MOTOR



S1592389	AC		- AC digital version
S1592388			- AC with Sound + Panto (Premium line version)
S1592381	DC	=	- DC analogic version
S1592380	=		- DC with Sound + Panto (Premium line version)

EuroDual Locomotive 159 102-3



In cooperation with | In Kooperation mit: ITL Eisenbahngesellschaft - Captrain Deutschland GmbH

Ep.	VI
	266
	NEM660 21MTG
	FAN MOTOR



S1591029	AC		- AC digital version
S1591028			- AC with Sound + Panto (Premium line version)
S1591021	DC	=	- DC analogic version
S1591020	=		- DC with Sound + Panto (Premium line version)





Euro9000 Locomotive 2019 313-6



In cooperation with | In Kooperation mit: - LOKOMOTION Gesellschaft für Schienentraction mbH

Ep. VI

266

NEM680
Z1MTC

FAN
MOTOR

PowerPack



© Sebastian Bollmann

Q2 2026

- | | | | | |
|----------|------|---|---|--|
| S0193138 | ~ | 🔊 | 🚧 | - AC with Sound + Panto (Premium line version) |
| S0193131 | DC = | | | - DC analogic version |
| S0193130 | = | 🔊 | 🚧 | - DC with Sound + Panto (Premium line version) |

Euro9000 Locomotive 2019 320-1



In cooperation with | In Kooperation mit: - LTE Logistik- und Transport GmbH
- LTE Group Design

Ep. VI

266

NEM680
Z1MTC

FAN
MOTOR

PowerPack



© Martin Gobel

Q2 2026

- | | | | | |
|----------|------|---|---|--|
| S0193208 | ~ | 🔊 | 🚧 | - AC with Sound + Panto (Premium line version) |
| S0193201 | DC = | | | - DC analogic version |
| S0193200 | = | 🔊 | 🚧 | - DC with Sound + Panto (Premium line version) |

Euro9000 Locomotive 2019 319-3



In cooperation with | In Kooperation mit: - HSL Logistik GmbH
- Mathias Oestreich

Ep.	VI
	266
	NEM660 21MTG
	FAN MOTOR
	PowerPack



Q2 2026

© Andre Regenspurger

S0193198				- AC with Sound + Panto (Premium line version)
S0193191	DC	=		- DC analogic version
S0193190	=			- DC with Sound + Panto (Premium line version)

Euro9000 Locomotive 2019 308-6



In cooperation with | In Kooperation mit: - HSL Logistik GmbH
- Mathias Oestreich

Ep.	VI
	266
	NEM660 21MTG
	FAN MOTOR
	PowerPack



Q2 2026

© Andre Regenspurger

S0193088				- AC with Sound + Panto (Premium line version)
S0193081	DC	=		- DC analogic version
S0193080	=			- DC with Sound + Panto (Premium line version)



Euro9000 Locomotive 2019 315-1



In cooperation with | In kooperatie mit: - RTB Cargo GmbH
- Railcolor Design

Ep. VI
266
NEM680
21MTC
FAN
MOTOR
PowerPack



© Maarten Schoubben

Q2 2026				
S0193158	~	🔊	↔️	- AC with Sound + Panto (Premium line version)
S0193151	DC	=		- DC analogic version
S0193150	=	🔊	↔️	- DC with Sound + Panto (Premium line version)

Euro9000 Locomotive 2019 306-0



In cooperation with | In kooperatie mit: - RTB Cargo GmbH
- Railcolor Design

Ep. VI
266
NEM680
21MTC
FAN
MOTOR
PowerPack



© Maarten Schoubben

Q2 2026				
S0193068	~	🔊	↔️	- AC with Sound + Panto (Premium line version)
S0193061	DC	=		- DC analogic version
S0193060	=	🔊	↔️	- DC with Sound + Panto (Premium line version)

NEW

Euro9000 Locomotive 2019 303-7



In cooperation with | In Kooperation mit: - Rail Force One
- Railcolor Design

Ep.	VI
	266
	NEM660 21MTC
	FAN MOTOR
	PowerPack



Q2 2025

Pre-production sample | Handmuster

S0193039	AC		- AC digital version
S0193038			- AC with Sound + Panto (Premium line version)
S0193031	DC	=	- DC analogic version
S0193030	=		- DC with Sound + Panto (Premium line version)

Euro9000 Locomotive 2019 310-2



In cooperation with | In Kooperation mit: - LOKOMOTION Gesellschaft für Schienentraktion mbH
- Railcolor Design

Ep.	VI
	266
	NEM660 21MTC
	FAN MOTOR
	PowerPack



Q2 2025

Pre-production sample | Handmuster

S0193109	AC		- AC digital version
S0193108			- AC with Sound + Panto (Premium line version)
S0193101	DC	=	- DC analogic version
S0193100	=		- DC with Sound + Panto (Premium line version)



Euro9000 Locomotive 2019 307-8



In cooperation with | In Kooperation mit: - HSL Logistik GmbH
- Mathias Oestreich

- Ep. VI
- 266
- NEM660 21MTC
- FAN MOTOR
- PowerPack



Q2 2025

Pre-production sample | Handmuster

- | | | |
|-----------------|-------|--|
| S0193079 | AC ~ | - AC digital version |
| S0193078 | ~ 🔊 🚧 | - AC with Sound + Panto (Premium line version) |
| S0193071 | DC = | - DC analogic version |
| S0193070 | = 🔊 🚧 | - DC with Sound + Panto (Premium line version) |

Euro9000 Locomotive 2019 314-4



In cooperation with | In Kooperation mit: - HSL Logistik GmbH
- Mathias Oestreich

- Ep. VI
- 266
- NEM660 21MTC
- FAN MOTOR
- PowerPack



Q2 2025

Pre-production sample | Handmuster

- | | | |
|-----------------|-------|--|
| S0193149 | AC ~ | - AC digital version |
| S0193148 | ~ 🔊 🚧 | - AC with Sound + Panto (Premium line version) |
| S0193141 | DC = | - DC analogic version |
| S0193140 | = 🔊 🚧 | - DC with Sound + Panto (Premium line version) |

Euro9000 Locomotive 2019 305-2



In cooperation with | In Kooperation mit: - RTB Cargo GmbH
- Railcolor Design

- Ep. VI
- 266
- NEM660 21MTC
- FAN MOTOR
- PowerPack



Q2 2025

Pre-production sample | Handmuster

S0193059	AC ~	- AC digital version
S0193058	~ 🔊 🚧	- AC with Sound + Panto (Premium line version)
S0193051	DC =	- DC analogic version
S0193050	= 🔊 🚧	- DC with Sound + Panto (Premium line version)

Euro9000 Locomotive 2019 311-0



In cooperation with | In Kooperation mit: - RTB Cargo GmbH
- Railcolor Design

- Ep. VI
- 266
- NEM660 21MTC
- FAN MOTOR
- PowerPack



Q2 2025

Pre-production sample | Handmuster

S0193119	AC ~	- AC digital version
S0193118	~ 🔊 🚧	- AC with Sound + Panto (Premium line version)
S0193111	DC =	- DC analogic version
S0193110	= 🔊 🚧	- DC with Sound + Panto (Premium line version)



Euro9000 Locomotive 2019 318-5



In cooperation with | In Kooperation mit: - railCare AG

Ep.	VI
	266
	NEM660 21MTC
	FAN MOTOR
	PowerPack



Q2 2025

Pre-production sample | Handmuster

S0193189	AC ~	- AC digital version
S0193188	~	- AC with Sound + Panto (Premium line version)
S0193181	DC =	- DC analogic version
S0193180	=	- DC with Sound + Panto (Premium line version)

Euro9000 Locomotive 2019 309-4



In cooperation with | In Kooperation mit: - BBL LOGISTIK GmbH

Ep.	VI
	266
	NEM660 21MTC
	FAN MOTOR
	PowerPack



Q2 2025

Pre-production sample | Handmuster

S0193059	AC ~	- AC digital version
S0193058	~	- AC with Sound + Panto (Premium line version)
S0193051	DC =	- DC analogic version
S0193050	=	- DC with Sound + Panto (Premium line version)

Euro6000 Locomotive 6013-3



In cooperation with | En collaboration avec: - CFL Cargo

Ep.	VI
	266
	NEM660 21MTC
	PowerPack



Q1 2026

© Le réseau des trois frontières

S0060138				- AC with Sound + Panto (Premium line version)
S0060131	DC	=		- DC analogic version
S0060130	=			- DC with Sound + Panto (Premium line version)

Euro6000 Locomotive 6015-8



In cooperation with | En collaboration avec: - CFL Cargo

Ep.	VI
	266
	NEM660 21MTC
	PowerPack



Q1 2026

© Le réseau des trois frontières

S0060158				- AC with Sound + Panto (Premium line version)
S0060151	DC	=		- DC analogic version
S0060150	=			- DC with Sound + Panto (Premium line version)



Euro6000 Locomotive 256 106-7



In cooperation with | En cooperación con: - Renfe Mercancías

Ep. VI
266
NEM660
21MTC
PowerPack



© Nelso Silva

Q1 2026			
S2561068	~		- AC with Sound + Panto (Premium line version)
S2561061	DC =		- DC analogic version
S2561060	=		- DC with Sound + Panto (Premium line version)

Euro6000 Locomotive 6045-5



In cooperation with | En cooperación con: - GOTRANSPORT

Ep. VI
266
NEM660
21MTC
PowerPack



© GOTRANSPORT

Q1 2026			
S0060158	~		- AC with Sound + Panto (Premium line version)
S0060151	DC =		- DC analogic version
S0060150	=		- DC with Sound + Panto (Premium line version)

Euro6000 Locomotive 6007-5



In cooperation with | En cooperación con | En coopération avec: - Transfesa Logistics S.A. and DB Cargo AG
- Loc&More

Ep.	VI
	266
	NEM660 Z1MTC



S0060079	AC		- AC digital version	
S0060078				- AC with Sound + Panto (Premium line version)
S0060071	DC		- DC analogic version	
S0060070				- DC with Sound + Panto (Premium line version)

Euro6000 Locomotive 6006-7



In cooperation with | En cooperación con | En coopération avec: - Transfesa Logistics S.A. and DB Cargo AG

Ep.	VI
	266
	NEM660 Z1MTC



S0060069	AC		- AC digital version	
S0060068				- AC with Sound + Panto (Premium line version)
S0060061	DC		- DC analogic version	
S0060060				- DC with Sound + Panto (Premium line version)



Euro6000 Locomotive 256 014-3



In cooperation with | En cooperación con: - Captrain España

Ep.	VI
	266
	NEM660 Z1MTC



S2560148				- AC with Sound + Panto (Premium line version)
S2560141	DC	=		- DC analogic version
S2560140	=			- DC with Sound + Panto (Premium line version)

Euro6000 Locomotive 6008-3



In cooperation with | En cooperación con | En coopération avec: - Captrain España
- Captrain France

Ep.	VI
	266
	NEM660 Z1MTC



S0060088				- AC with Sound + Panto (Premium line version)
S0060081	DC	=		- DC analogic version
S0060080	=			- DC with Sound + Panto (Premium line version)

Euro6000 Locomotive 6001-8



In cooperation with | En cooperación con | En coopération avec: - Captrain España
- Captrain France

Ep.	VI
	266
	NEM660 21MTC



S0060019	AC		- AC digital version
S0060018			- AC with Sound + Panto (Premium line version)
S0060011	DC		- DC analogic version
S0060010			- DC with Sound + Panto (Premium line version)

Euro6000 Locomotive 256 007-7



In cooperation with | En cooperación con: - Captrain España

Ep.	VI
	266
	NEM660 21MTC



S2560078			- AC with Sound + Panto (Premium line version)
S2560071	DC		- DC analogic version
S2560070			- DC with Sound + Panto (Premium line version)



Euro6000 Locomotive 256 104-2



In cooperation with | En cooperación con: - Renfe Mercancías

Ep.	VI
	266
	NEM660 21MTC



S2561031	DC =	- DC analogic version
S2561030	=	- DC with Sound + Panto (Premium line version)

Euro6000 Locomotive 256 004-4



In cooperation with | En cooperación con: - Continental Rail S.A.

Ep.	VI
	266
	NEM660 21MTC



S2560041	DC =	- DC analogic version
S2560040	=	- DC with Sound + Panto (Premium line version)

Euro6000 Locomotive 256 011-9



In cooperation with | Em cooperação com | En cooperación con: - Medway Iberia S.A.

Ep.	VI
	266
	NEM660 Z1MTC



S2560118				- AC with Sound + Panto (Premium line version)
S2560111	DC	=		- DC analogic version
S2560110	=			- DC with Sound + Panto (Premium line version)

Euro6000 Locomotive 256 201-6



In cooperation with | Em cooperação com | En cooperación con: - Medway Iberia S.A.

Ep.	VI
	266
	NEM660 Z1MTC



S2562018				- AC with Sound + Panto (Premium line version)
S2562011	DC	=		- DC analogic version
S2562010	=			- DC with Sound + Panto (Premium line version)



Euro6000 Locomotive 256 017-6



In cooperation with | Em cooperação com | En cooperación con: - Medway Iberia S.A.
- Boa Mistura

Ep.	VI
	266
	NEM660 Z1MTC



S2560178				- AC with Sound + Panto (Premium line version)
S2560171	DC	=		- DC analogic version
S2560170	=			- DC with Sound + Panto (Premium line version)



© Nelso Silva

Euro4001 Locomotive E4001 3982-1



In cooperation with | En collaboration avec: - Captrain France

Ep.	VI
	266
	FAN MOTOR
	PowerPack



© Captrain France/Romain Vergneres

Q4 2025

S0039828			- AC with Sound (Premium line version)
S0039821	DC	=	- DC analogic version
S0039820	=		- DC with Sound (Premium line version)

Euro4001 Locomotive E4001 3971-4



In cooperation with | En collaboration avec: - Captrain France

Ep.	VI
	266
	FAN MOTOR
	PowerPack



© Captrain France/edgar_4402

Q4 2025

S0039718			- AC with Sound (Premium line version)
S0039711	DC	=	- DC analogic version
S0039710	=		- DC with Sound (Premium line version)



Euro4001 Locomotive 337.006



In cooperation with | En cooperación con: - CSP Logitren

Ep.	VI
266	
NEM660	21MTG
FAN MOTOR	
PowerPack	



© Alberto Rodríguez

Q4 2025

- S3370068** ~ 🔊 - AC with Sound (Premium line version)
- S3370061** DC = - DC analogic version
- S3370060** = 🔊 - DC with Sound (Premium line version)

Euro4001 Locomotive 337.000



In cooperation with | En cooperación con: - ferrovial

Ep.	VI
266	
NEM660	21MTG
FAN MOTOR	
PowerPack	



© ferrovial/Stadler

Q4 2025

- S3379998** ~ 🔊 - AC with Sound (Premium line version)
- S3379991** DC = - DC analogic version
- S3379990** = 🔊 - DC with Sound (Premium line version)

NEW

Euro4001 Locomotive 337.002



In cooperation with | En cooperación con: - Medway

Ep.	VI
266	
NEM660 Z1MTC	
FAN MOTOR	
PowerPack	



Q4 2025

- | | | |
|----------|------|--|
| S3370028 | ~ 🔊 | - AC with Sound (Premium line version) |
| S3370021 | DC = | - DC analogic version |
| S3370020 | = 🔊 | - DC with Sound (Premium line version) |



© Diego Sánchez



Euro4000 Locomotive E4028



In cooperation with | En coopération avec: - Captrain France

Ep.	VI
	266
	NEM660 Z1MTC

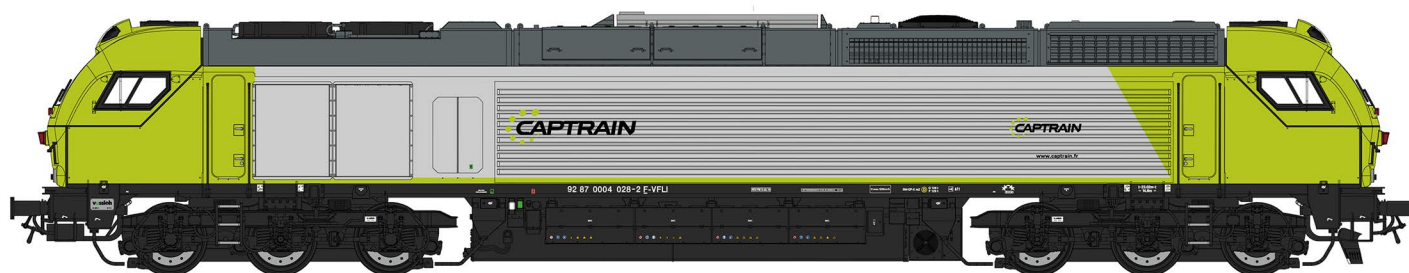

Q3 2025

S402823 DC = - DC analogic version

New "Captrain" livery that replaced the old "VFLI" livery.

Nouvelle livrée "Captrain" qui a remplacé l'ancienne livrée "VFLI".

Euro4000 Locomotive E4024



In cooperation with | In Kooperation mit: - Europorte

Ep.	VI
	266
	NEM660 Z1MTC



Q3 2025

S402423 DC = - DC analogic version

Special "oleo100" livery

Livrée spéciale "oleo100"

Sonderlackierung "oleo100"

NEW

Euro4000 Locomotive 335.033, "Matilde"



In cooperation with | Em cooperação com: - Medway Iberia

Ep.	VI
266	
NEM660	21MTC

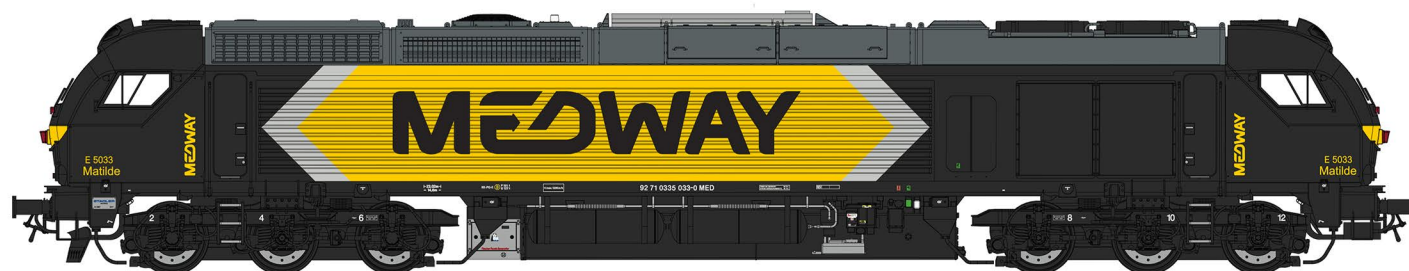

Q3 2025

S503323 DC =

- DC analogic version

Medway E 5033 locomotive baptized as "Matilde" with modernized LED lightmarkers
Locomotiva Medway E 5033 batizada de "Matilde" com farolins LED modernizados

Euro4000 Locomotive 335.003



In cooperation with | En cooperación con: - Captrain España

Ep.	VI
266	
NEM660	21MTC

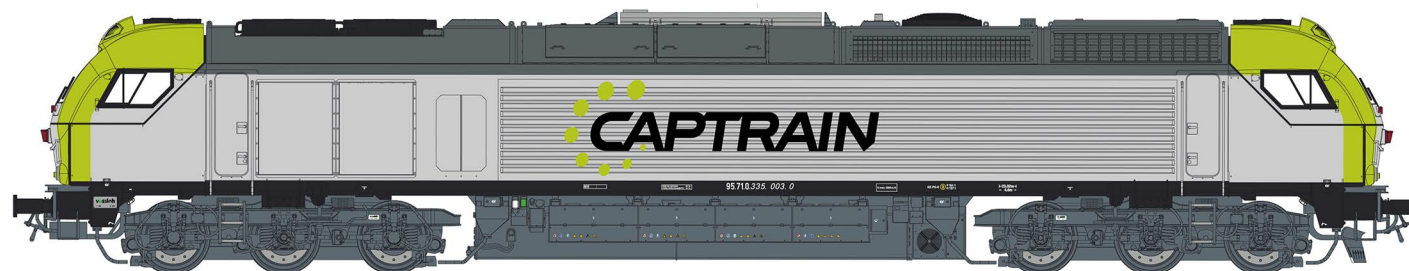

Q3 2025

S500323 DC =

- DC analogic version

New "Captrain" livery that replaced the old "Comsa Rail" livery.
Nueva librea "Captrain" que reemplazó la antigua librea "Comsa Rail".



Euro4000 Locomotive 335.020



In cooperation with | Em cooperação com: - Captrain España
- Ibercarga Rail, S.A. (Joint Venture Takargo Rail & Captrain España)

Ep.	VI
266	
NEM660	21MTC

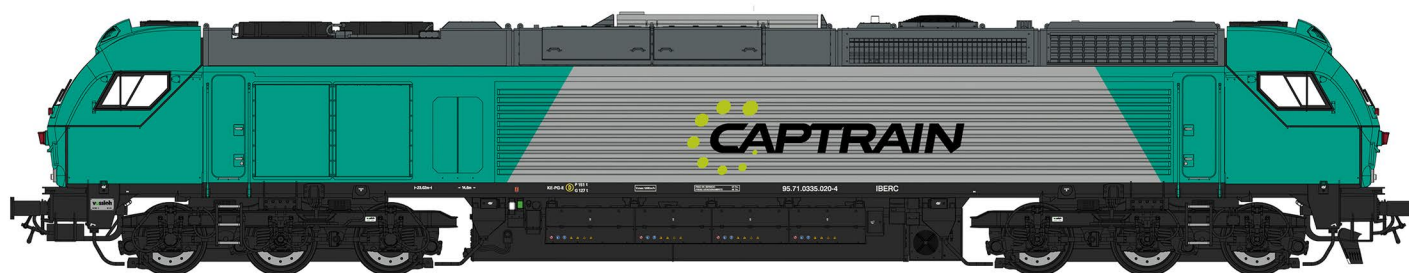
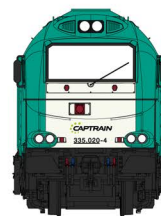

Q3 2025

S502023 DC = - DC analogic version
Alpha Trains locomotive hired to Captrain España/Ibercarga
Locomotiva da Alpha Trains alugada a Captrain España/Ibercarga

Euro4000 Locomotive 6002



In cooperation with | Em cooperação com: - Takargo Rail S.A.

Ep.	VI
266	
NEM660	21MTC

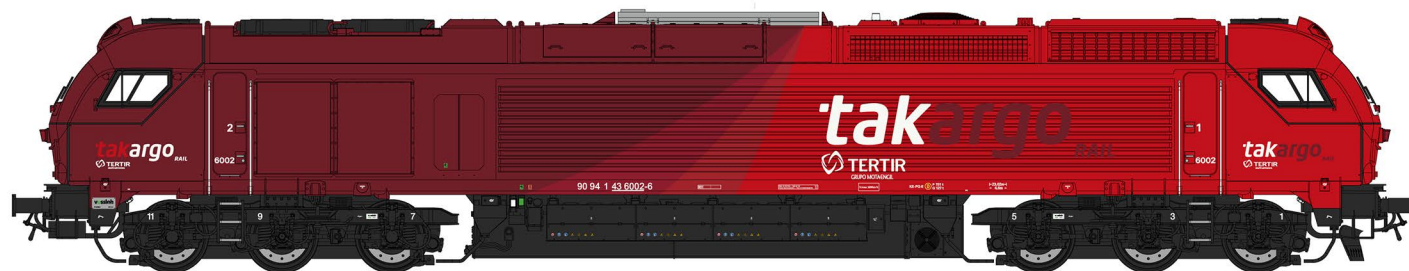

Q3 2025

S600223 DC = - DC analogic version
Takargo Euro4000 locomotive with modernized LED lightmarkers.
Locomotiva Takargo Euro4000 com farolins LED modernizados.



© Nelso Silva



© Nelso Silva



Diesel Locomotive class ML 440 C

 AL - Augsburg Localbahn GmbH

Krauss-Maffei ML 440 C, Augsburg Localbahn: - Loc. "98 80 3504 107-4 D-AULOC", with KM factory number 18326.
- Lok "98 80 3504 107-4 D-AULOC", und mit KM Fabriknummer 18326.

Ep.	VI
	100
	E24
	PowerPack



Q4 2026

© Patrick Böttger

S0183268				- AC with Sound + Digital couplers (<i>Premium line</i> version)
S0183261	DC	=		- DC analogic version
S0183260	=			- DC with Sound + Digital couplers (<i>Premium line</i> version)

Diesel Locomotive class ML 440 C

 RAG - Ruhrkohle AG

Krauss-Maffei ML 440 C, RAG Ruhrkohle AG : - Loc. "465", with KM factory number 18856.
- Lok "465", und mit KM Fabriknummer 18856.

Ep.	IV
	100
	E24
	PowerPack



Q4 2026

© Dr. Werner Söffing

S0188568				- AC with Sound + Digital couplers (<i>Premium line</i> version)
S0188561	DC	=		- DC analogic version
S0188560	=			- DC with Sound + Digital couplers (<i>Premium line</i> version)

Diesel Locomotive class ML 440 C

 Bundeswehr

Krauss-Maffei ML 440 C, Bundeswehr: - Loc. "0028368", with KM factory number 18334.
- Lok "0028368", und mit KM Fabriknummer 18334.

Ep.	V
	100
	E24
PowerPack	



© Dietmar Stresow

Q4 2026

S0183348				- AC with Sound + Digital couplers (Premium line version)
S0183341	DC	=		- DC analogic version
S0183340	=			- DC with Sound + Digital couplers (Premium line version)

Diesel Locomotive class ML 440 C

 EFW - Eisenbahnfreunde Wetterau e. V.

Krauss-Maffei ML 440 C, EFW: - Loc. "98 80 3504 121-5 D-EBEFW", with KM factory number 18352.
- Lok "98 80 3504 121-5 D-EBEFW", und mit KM Fabriknummer 18352.

Ep.	VI
	100
	E24
PowerPack	



© Patrick Paulsen

Q4 2026

S0183528				- AC with Sound + Digital couplers (Premium line version)
S0183521	DC	=		- DC analogic version
S0183520	=			- DC with Sound + Digital couplers (Premium line version)



Diesel Locomotive class ML 440 C



AlzChem Hart GmbH

Krauss-Maffei ML 440 C, AlzChem: - Loc. "5- Emma", with KM factory number 18422.
- Lok "5- Emma", und mit KM Fabriknummer 18422.

Ep. V-VI
100
E24
PowerPack



Q4 2026

© Jörg van Essen

S0184228	~	🔊	🚂	- AC with Sound + Digital couplers (Premium line version)
S0184221	DC	=		- DC analogic version
S0184220	=	🔊	🚂	- DC with Sound + Digital couplers (Premium line version)

Diesel Locomotive class ML 440 C



SerFer - Servizi Ferroviari S.r.l.

Krauss-Maffei ML 440 C, SerFer: - Loc. "K 060", with KM factory number 18384.
- Locomotiva "K 060", con numero di fabbrica KM 18384.

Ep. V-VI
100
E24
PowerPack



Q4 2026

© Patrick Paulsen

S0183848	~	🔊	🚂	- AC with Sound + Digital couplers (Premium line version)
S0183841	DC	=		- DC analogic version
S0183840	=	🔊	🚂	- DC with Sound + Digital couplers (Premium line version)

Diesel Locomotive class ML 500 C



DB - Deutsche Bundesbahn

Krauss-Maffei ML 500 C, Deutsche Bundesbahn: - Loc. "V 50 002", with KM factory number 18357.
- Lok "V 50 002", und mit KM Fabriknummer 18357.

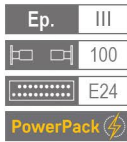

Q4 2026

Photomontage

© Peter Driesch

S0183578				- AC with Sound + Digital couplers (Premium line version)
S0183571	DC	=		- DC analogic version
S0183570	=			- DC with Sound + Digital couplers (Premium line version)

Diesel Locomotive class ML 500 C



Hoesch Hüttenwerke AG, Dortmund / DE - Dortmunder Eisenbahn GmbH

Krauss-Maffei ML 500 C, Hoesch / DE: - Loc. "525", with KM factory number 18320.
- Lok "525", und mit KM Fabriknummer 18320.

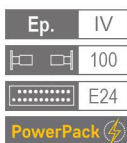

Q4 2026

© Ingmar Weidig

S0183208				- AC with Sound + Digital couplers (Premium line version)
S0183201	DC	=		- DC analogic version
S0183200	=			- DC with Sound + Digital couplers (Premium line version)



Diesel Locomotive class ML 500 C



WPN - Württembergisches Privatbahnmuseum Nürtingen

Krauss-Maffei ML 500 C, WPN: - Loc. "V 50 001", with KM factory number 18356.
- Lok "V 50 001", und mit KM Fabriknummer 18356.

Ep. VI
100
E24
PowerPack



Q4 2026

© Michael Mrugalla

S0183568	~	🔊	🚂	- AC with Sound + Digital couplers (Premium line version)
S0183561	DC	=		- DC analogic version
S0183560	=	🔊	🚂	- DC with Sound + Digital couplers (Premium line version)

Diesel Locomotive class ML 500 C



K+S - Kali und Salz GmbH

Krauss-Maffei ML 500 C, K+S: - Loc. "6", with KM factory number 18722.
- Lok "6", und mit KM Fabriknummer 18722.

Ep. V
100
E24
PowerPack



Q4 2026

© Wikipedia/Gunnar1m

S0187228	~	🔊	🚂	- AC with Sound + Digital couplers (Premium line version)
S0187221	DC	=		- DC analogic version
S0187220	=	🔊	🚂	- DC with Sound + Digital couplers (Premium line version)

Diesel Locomotive class ML 500 C



MRW - Mannesmannröhren-Werke AG

Krauss-Maffei ML 500 C, MRW: - Loc. "8", with KM factory number 19303.
- Lok "8", und mit KM Fabriknummer 19303.

Ep.	V
	100
	E24
PowerPack	



Q4 2026

© Ingmar Weidig

S0183038				- AC with Sound + Digital couplers (Premium line version)
S0183031	DC	=		- DC analogic version
S0183030	=			- DC with Sound + Digital couplers (Premium line version)

Diesel Locomotive class ML 500 C



SerFer - Servizi Ferroviari S.r.l.

Krauss-Maffei ML 500 C, SerFer: - Loc. "K 092", with KM factory number 18218.
- Locomotiva "K 092", con numero di fabbrica KM 18218.

Ep.	V-VI
	100
	E24
PowerPack	



Q4 2026

© Frank Glaubitz

S0182188				- AC with Sound + Digital couplers (Premium line version)
S0182181	DC	=		- DC analogic version
S0182180	=			- DC with Sound + Digital couplers (Premium line version)



Locomotiva Diesel 1455



In cooperation with | Em cooperação com: - Comboios de Portugal, E.P.E

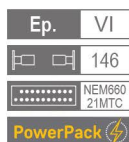

Q2 2025

S145523

DC =

- Versão DC analógica

Locomotiva CP 1455 em esquema CP azul "retro".

Locomotiva Diesel 1413



In cooperation with | Em cooperação com: - Comboios de Portugal, E.P.E

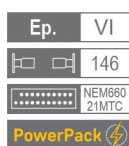

Q2 2025

S141324

DC =

- Versão DC analógica

Locomotiva CP 1413 em esquema CP azul "retro".

NEW

LOCOMOTIVES
H0

Locomotiva Diesel 1461



In cooperation with | Em cooperação com: - Comboios de Portugal, E.P.E

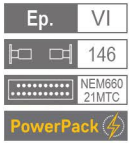

Q2 2025

S146124

DC =

- Versão DC analógica
Locomotiva CP 1461 em esquema CP laranja.

Locomotiva Diesel 1436



In cooperation with | Em cooperação com: - Comboios de Portugal, E.P.E

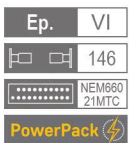

Q2 2025

S143623

DC =

- Versão DC analógica
Locomotiva CP 1436 em esquema CP laranja.



Locomotiva Diesel 1449



In cooperation with | Em cooperação com: - Takargo Rail S.A.

Ep.	VI
	146
	NEM660 21MTC
	PowerPack



Q2 2025

S144923 DC = - Versão DC analógica
Locomotiva 9094 110 1449-3 em esquema Takargo Rail.

Locomotiva Diesel 1446



In cooperation with | Em cooperação com: - Medway Iberia

Ep.	VI
	146
	NEM660 21MTC
	PowerPack



Q2 2025

S144623 DC = - Versão DC analógica
Locomotiva 9094 110 1446-9 em esquema Medway.

NEW

LOCOMOTIVES
H0

Locomotiva Diesel 1404



In cooperation with | Em cooperação com: - Medway Iberia

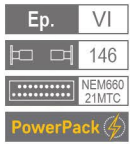

Q2 2025

S140423

DC =

- Versão DC analógica

Locomotiva 9094 110 1404-8 em esquema Medway.



© Valério dos Santos



Locomotiva Elétrica 2503



Ep.	IV
	182
	NEM660 21MTC

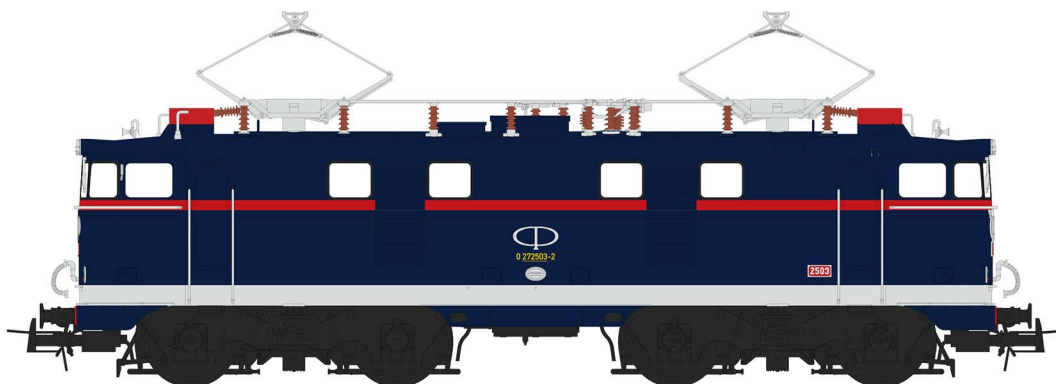

Q4 2026

S250326

DC =

- Versão DC analógica

Locomotiva CP 2503 em esquema CP azul, anos 70, com numeração UIC.

Locomotiva Elétrica 2514



Ep.	V
	182
	NEM660 21MTC

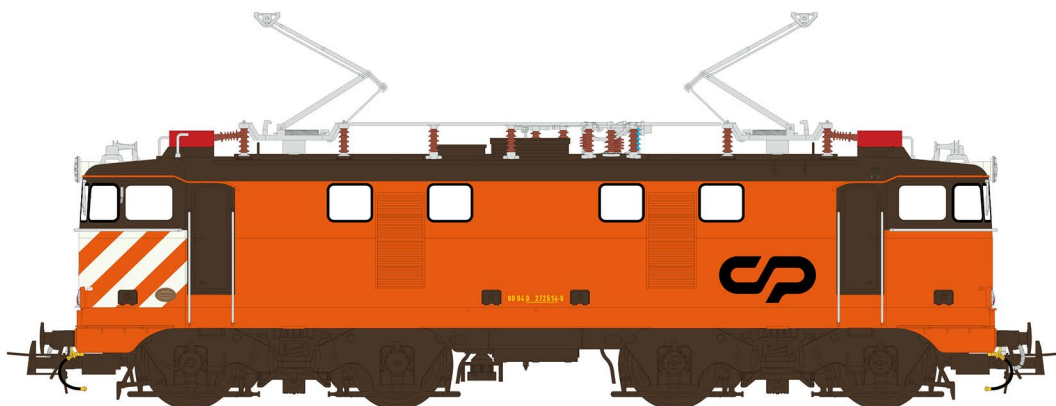

Q4 2026

S251426

DC =

- Versão DC analógica

Locomotiva CP 1413 em esquema CP laranja, anos 2000.

Locomotiva Elétrica 2506



Ep.	V
	182
NEM660 21MTC	

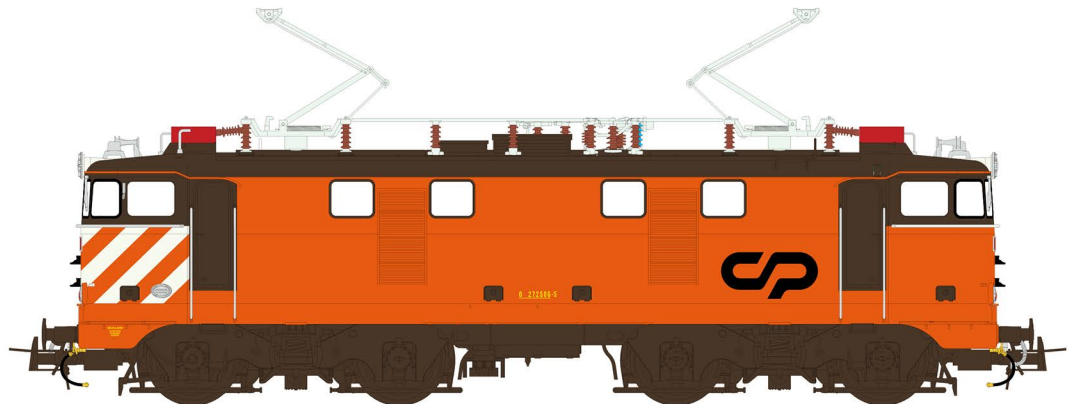

Q4 2026

S250626

DC =

- Versão DC analógica

Locomotiva CP 2506 em esquema CP laranja, anos 2000, com UM.

Locomotiva Elétrica 2552



Ep.	V
	182
NEM660 21MTC	

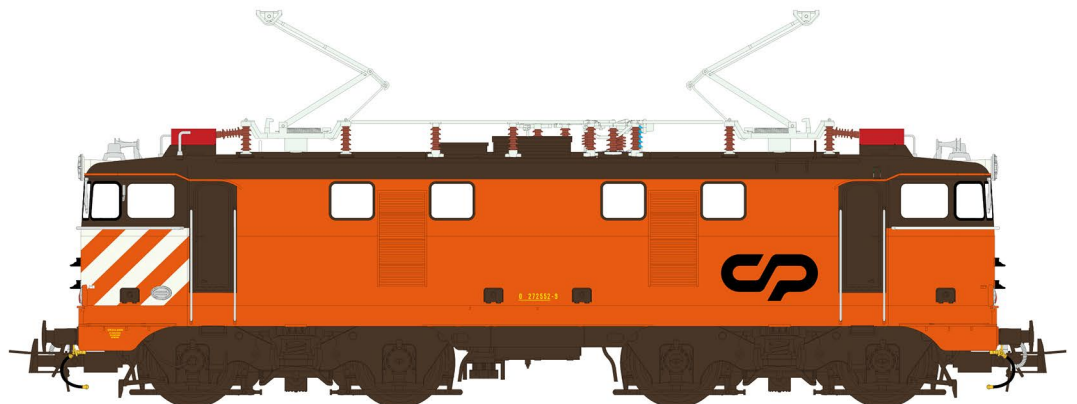

Q4 2026

S255226

DC =

- Versão DC analógica

Locomotiva CP 2552 em esquema CP laranja, anos 2000, com UM.



Locomotiva Elétrica 2570



Ep.	III
	182
	NEM660 21MTC

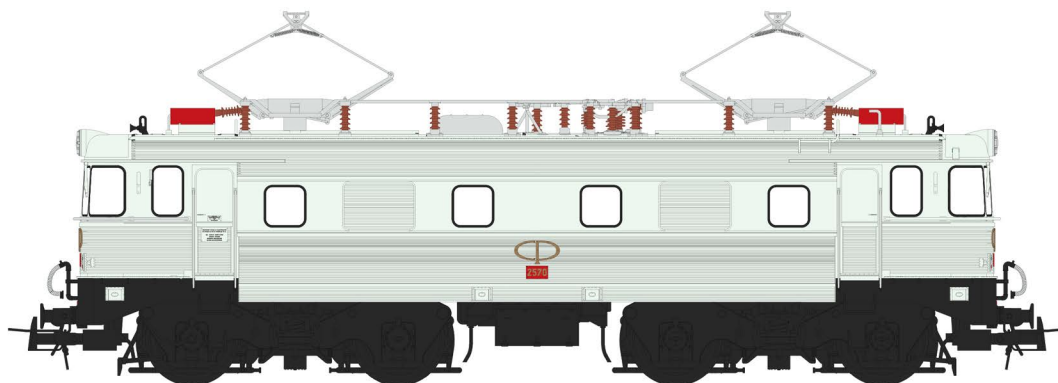
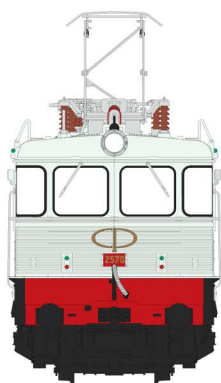

Q4 2026

S257026

DC =

- Versão DC analógica

Locomotiva CP 2570 em esquema CP original, anos 70.

Locomotiva Elétrica 2564



Ep.	III
	V
	NEM660 21MTC

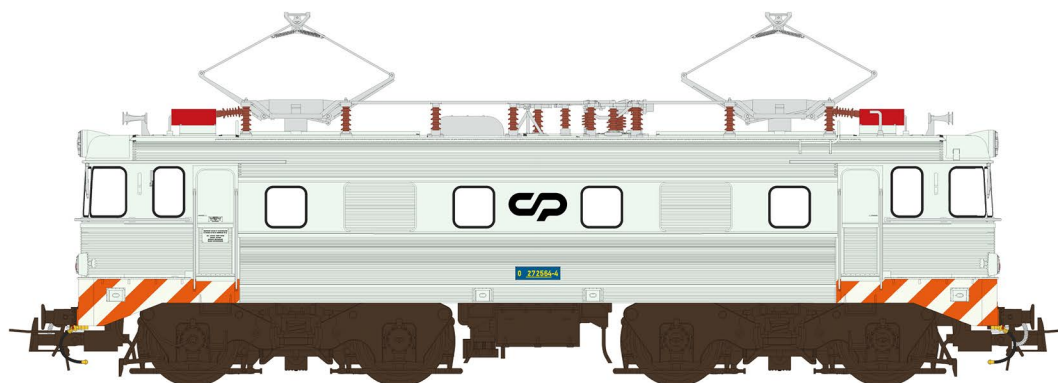
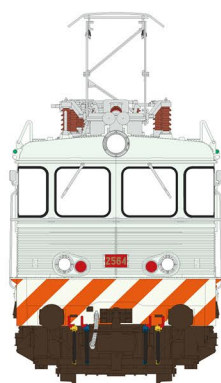

Q4 2026

S256426

DC =

- Versão DC analógica

Locomotiva CP 2564 em esquema CP laranja, anos 90.

Locomotiva Elétrica 2551



Ep.	V
	182
	NEM660 21MTC

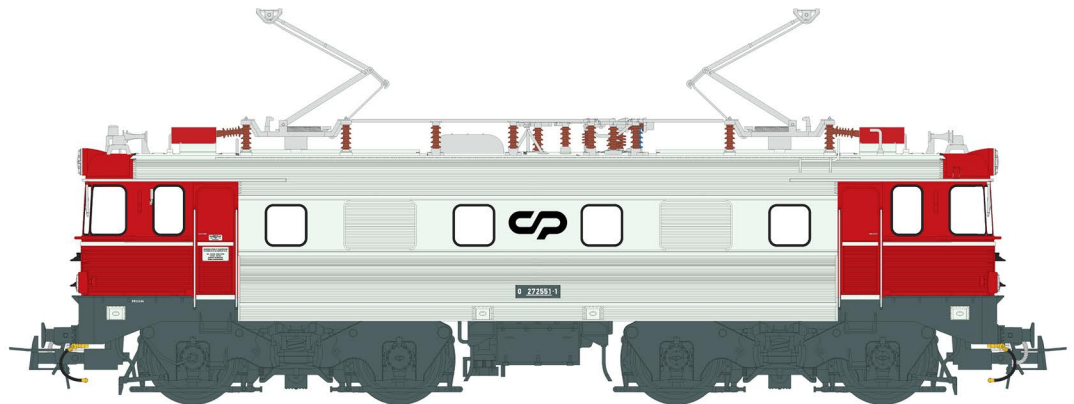

Q4 2026

S255126

DC =

- Versão DC analógica

Locomotiva CP 2551 em esquema CP vermelho, anos 2000. com UM.

Locomotiva Elétrica 2566



Ep.	V
	182
	NEM660 21MTC

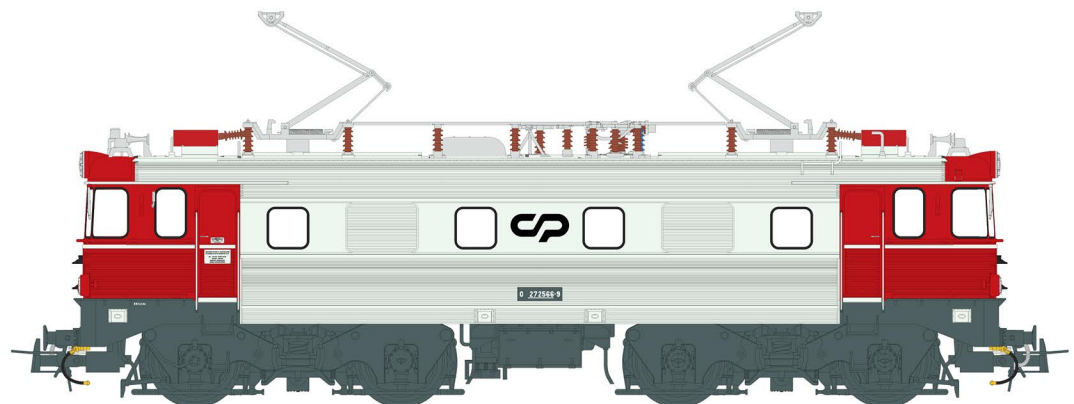
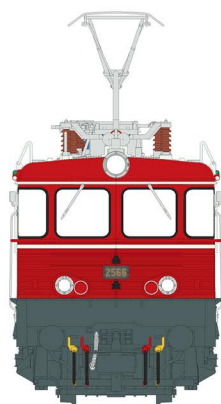

Q4 2026

S256626

DC =

- Versão DC analógica

Locomotiva CP 2566 em esquema CP vermelho, anos 2000. com UM.



The future of regional and suburban rail services... soon also in H0 gauge!

The Stadler FLIRT (Fast Light Innovative Regional Train) is a family of versatile, modern trains designed and built by Stadler Rail, a Swiss manufacturer. These trains are primarily used for regional and suburban rail services but can also be adapted for long-distance routes. They are notable for their modularity, efficiency, and comfort, making them a popular choice for operators in over 20 countries worldwide.

Since their introduction in the early 2000s, the Stadler FLIRT trains have gained a reputation for their modern design, operational flexibility, and efficiency, making them a popular choice for both regional and intercity rail transport.

In parallel with the real life prototype, Sudexpress is also working on detailed implementation of the Stadler FLIRT3 Rail cars as a high-quality H0 Scale model. As with our EuroDual and Euro9000 models, these will also boast spectacular detailing and optimal operational characteristics.

We will be communicating further information about the new FLIRT3 models shortly.

Die Zukunft des Regional- und S-Bahn-Verkehrs... bald auch in Spur Ho!

Der Stadler FLIRT (Flinker Leichter Intercity- und Regional-Triebzug) gehört zu einer Serie von modernen Zügen, die vom Schweizer Hersteller Stadler Rail entwickelt und gebaut werden. Diese Züge werden hauptsächlich im Regional- und Vorortverkehr eingesetzt, können aber auch für den Fernverkehr angepasst werden. Sie zeichnen sich durch ihre Modularität, ihre Effizienz und ihren Komfort aus, was sie zu einer beliebten Wahl für Betreiber in über 20 Ländern weltweit macht.

Seit ihrer Einführung Anfang der 2000er Jahre sind die Stadler FLIRT-Züge für ihr modernes Design, ihre betriebliche Flexibilität und ihre Effizienz bekannt, was sie zu einer beliebten Wahl sowohl für den Regional- als auch für den Intercity-Bahnverkehr macht.

Parallel zum realen Vorbild arbeitet Sudexpress auch an der detaillierten Umsetzung der Stadler FLIRT3-Triebwagen als hochwertiges H0-Modell. Wie unsere EuroDual und Euro9000 werden auch diese über eine spektakuläre Detaillierung und optimale Betriebseigenschaften verfügen.

Weitere Informationen zu den neuen FLIRT3-Modellen werden wir in Kürze kommunizieren.



RAIL CARS
H0

FLIRT3

Fast Light Intercity and Regional Train

STADLER



© Nelso Silva



© Nelso Silva



Automotoras diesel Nohab série CP 0100

Modelo de construção híbrida, combinando a qualidade e o prestígio de um corpo em latão Norbrass com a precisão e rigor de um modelo em plástico e chassis metálico Sudexpress.



Automotora Diesel CFE AC2my 1005



Q3 2025

Ep. III Ref.: **SNAC00518** - Versão creme e verde CFE anos 40

Automotora Diesel CP My 101

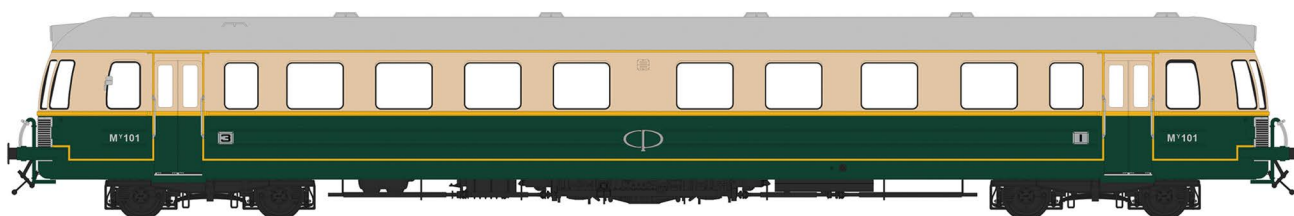

Q3 2025

Ep. III Ref.: **SNNY10118** - Versão creme e verde CP anos 50

Automotora Diesel CP My 115



Q3 2025

Ep. III Ref.: **SNNY11518** - Versão azul, vermelho e prata CP anos 60

Automotora Diesel CP My 108



Q3 2025

Ep. III Ref.: **SNNY10818** - Versão azul e vermelho CP anos 60

Automotora Diesel CP My 103

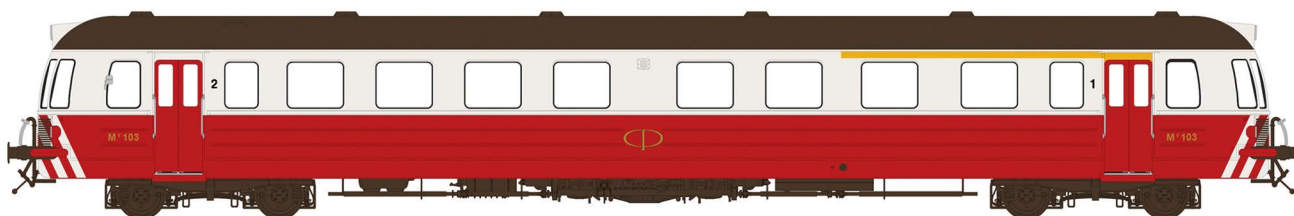

Q3 2025

Ep. IV Ref.: **SNCP10318** - Versão vermelho e branco com listas em "V" CP anos 70

NEW



© Richard Latten

**Automotora Diesel
CP 0110**

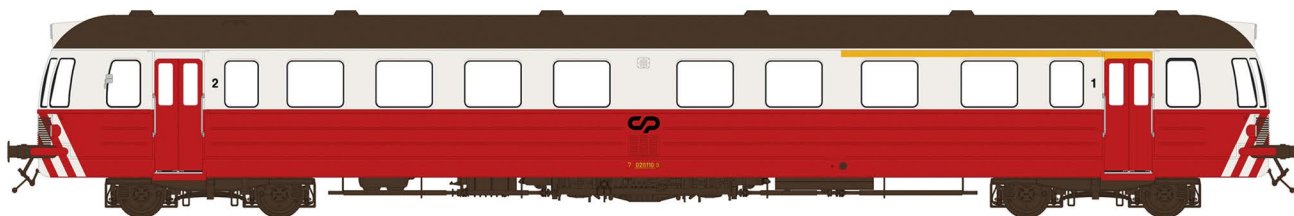

Q3 2025

NEXT 18 Ep. IV Ref.: **SNCP11018** - Versão vermelho e branco CP anos 70

**Automotora Diesel
CP 0111**

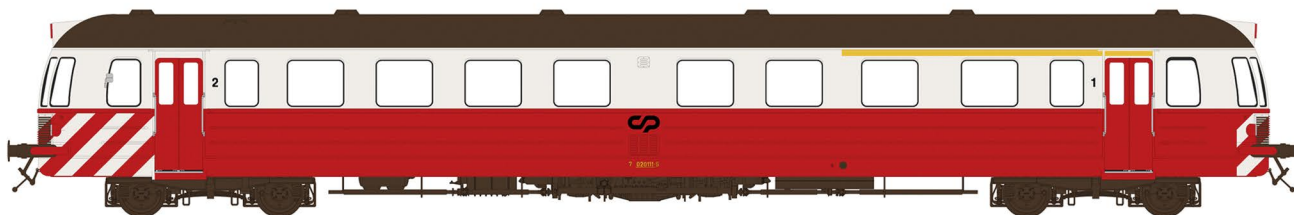

Q3 2025

NEXT 18 Ep. IV Ref.: **SNCP11118** - Versão vermelho e branco CP anos 80

**Automotora Diesel
CP 0109**



Q3 2025

NEXT 18 Ep. V Ref.: **SNCP10918** - Versão vermelho e branco CP anos 90

**Automotora Diesel
CP 0114**



Q3 2025

NEXT 18 Ep. V Ref.: **SNCP11418** - Versão vermelho e branco CP anos 90

**Automotora Diesel
CP 0101 Museu**



Q3 2025

NEXT 18 Ep. V Ref.: **SNCP10118** - Versão Museu CP anos 90

H0 1:87

PASSENGER COACHES
CARRUAGENS
PERSONENWAGEN

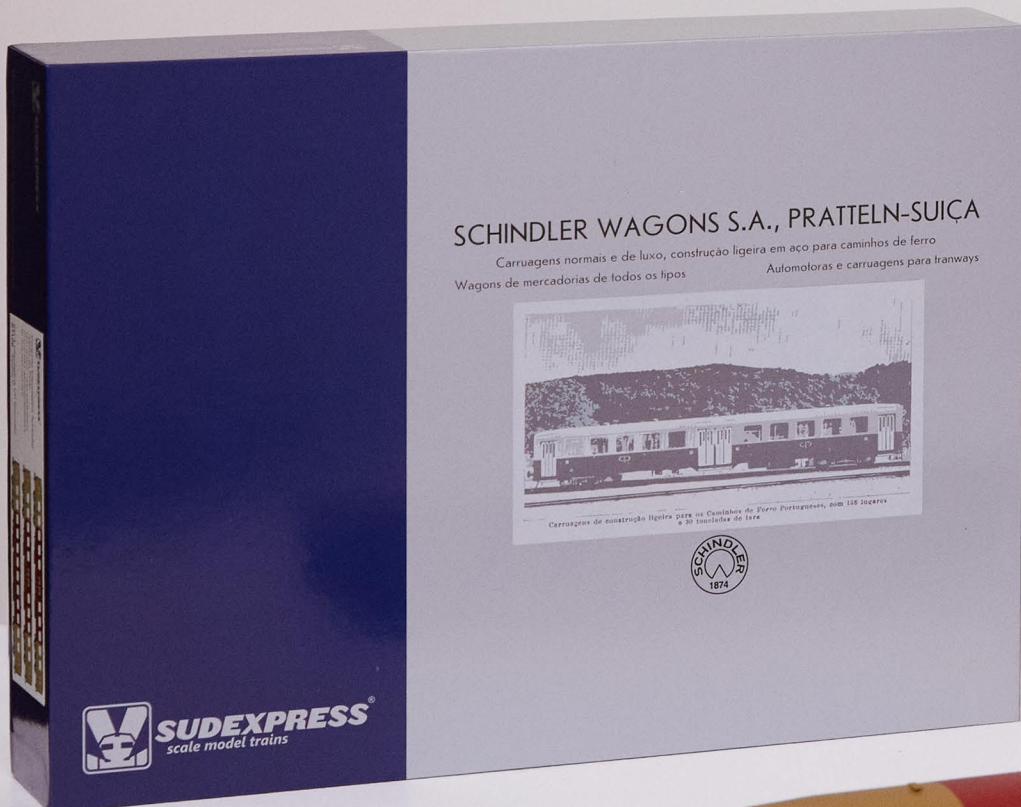





**Set 3 Carr. Sorefame | 3 pcs Sorefame set
"Sud Expresso I"**



Ep. IV
306



As Sorefame 21-40 foram indispensáveis nos serviços rápidos nacionais e internacionais entre Portugal e a fronteira franco-espanhola, com especial destaque para o icónico Sud Expresso e serviços especiais de emigrantes.



Q3 2025
70s - 80s
S1203

SET 3 pcs

- Conjunto composto pelas seguintes 3 carr. Sorefame | Set consisting of the following 3 Sorefame coaches:
- CP 21-40 001-0 - 2ª Classe, 11 Compart.
 - CP 21-40 019-2 - 2ª Classe, 11 Compart.
 - CP 21-40 022-6 - 2ª Classe, 11 Compart.

**Set 3 Carr. Sorefame | 3 pcs Sorefame set
"Sud Expresso II"**



Ep. V
306



As Sorefame 21-40 foram indispensáveis nos serviços rápidos nacionais e internacionais entre Portugal e a fronteira franco-espanhola, com especial destaque para o icónico Sud Expresso e serviços especiais de emigrantes.



Q3 2025
80s - 00s
S1204

SET 3 pcs

- Conjunto composto pelas seguintes 3 carr. Sorefame | Set consisting of the following 3 Sorefame coaches:
- CP 21-40 003-6 - 2ª Classe, 11 Compart.
 - CP 21-40 006-9 - 2ª Classe, 11 Compart.
 - CP 21-40 027-5 - 2ª Classe, 11 Compart.

NEW

PASSENGER COACHES H0

Set 3 Carr. Sorefame | 3 pcs Sorefame set "Rápido 60's - 80's"



Placas com numeração pré-UIC incluídas:
Plates with pre-UIC road numbers included:



Ep. III/IV
306



Q3 2025
60s - 80s
S1201

SET 3 pcs

- Conjunto composto pelas seguintes 3 carr. Sorefame | Set consisting of the following 3 Sorefame coaches:
- CP 21-69 010-7 (B11yf 1098) - 2ª Classe, 11 Compart. "Sorefame mini-saia"
- CP 21-69 048-7 (B11yf 1100) - 2ª Classe, 11 Compart. "Sorefame mini-saia"
- CP 21-69 050-3 (B11yf 1060) - 2ª Classe, 11 Compart. "Sorefame mini-saia"

Set 3 Carr. Sorefame | 3 pcs Sorefame set "Inter Regional c/ Bar"



Pormenor da vista do lado oposto da carr. bar | Detail view of the opposite side of the bar coach



Ep. V
306



Q3 2025
80s - 00s
S1202

SET 3 pcs

- Conjunto composto pelas seguintes 3 carr. Sorefame | Set consisting of the following 3 Sorefame coaches:
- CP 21-69 004-0 - 2ª Classe, 11 Compart. "Sorefame mini-saia"
- CP 21-69 034-7 - 2ª Classe, 11 Compart. "Sorefame mini-saia"
- CP 85-50 004-4 - 2ª Classe, 7 Compart. + Bar. "Sorefame mini-saia"



**Set 3 Carr. Sorefame | 3 pcs Sorefame set
"Foguete"**



Ep. IV

306



70s

S0119

SET 3 pcs

- Conjunto composto pelas seguintes 3 carr. Sorefame | Set consisting of the following 3 Sorefame coaches:
- CP A10yf 911 1ª Classe Compart.
- CP A10yf 912 1ª Classe Compart.
- CP A10yf 913 1ª Classe Compart.

**Set 2 Carr. Sorefame | 2 pcs Sorefame set
"Semidirecto 70's"**



Ep. IV

306



70s

S0219

SET 2 pcs

- Conjunto composto pelas seguintes 2 carr. Sorefame | Set consisting of the following 2 Sorefame coaches:
- CP 10-69 021 1ª Classe Compart.
- CP 30-69 001 Mista Compart.

Set 3 Carr. Sorefame | 3 pcs Sorefame set
"Rápido 80's"



Ep. IV
306



60s - 80s
S0319

SET 3 pcs

- Conjunto composto pelas seguintes 3 carr. Sorefame | Set consisting of the following 3 Sorefame coaches:
- CP 10-69 026 1ª Classe Compart.
- CP 30-69 002 Mista Compart.
- CP 20-69 001 2ª Classe Compart.

Set 3 Carr. Sorefame | 3 pcs Sorefame set
"Tranvia 70's"



Ep. IV
306



80s - 00s
S0619

SET 3 pcs

- Conjunto composto pelas seguintes 3 carr. Sorefame | Set consisting of the following 3 Sorefame coaches:
- CP 22-40 001 2ª Classe Salão
- CP 22-40 054 2ª Classe Salão
- CP 22-40 012 2ª Classe Salão



Furgão Sorefame, CP



Ep. IV

247



S9269551 - Dyf 551 furgão de bagagens (topos com intercomunicação de foles)

Furgão Sorefame, CP



Ep. IV

247



S9269006 - CP 92-69 006-9 furgão de bagagens (topos com intercomunicação de foles)

Furgão Sorefame, CP



Ep. V

247



S9269012 - CP 92-69 012-7 furgão de bagagens (topos com intercomunicação de Bourrelets)

Furgão Sorefame, CP



Ep. V

247



S9269004 - CP 92-69 004-4 furgão de bagagens (topos com intercomunicação de Bourrelets)

Furgão socorro, CP



Ep. V

247



S9269015 - CP 92-69 015-0 furgão socorro "PAMPILHOSA"

Furgão socorro, CP



Ep. V

247



S9269020 - CP 92-69 020-0 furgão socorro "ENTRONCAMENTO"

Furgão socorro, CP



Ep. V

247



S9750004 - CP 975 0 004-5 furgão socorro "CAMPOLIDE"

Furgão socorro, CP



Ep. VI

247



S9269150 - CP 92-69 015-0 furgão socorro "CONTUMIL"



Furgão gerador, CP



Ep. IV

247



S9269008 - CP 92-69 008-5 furgão gerador para carruagens climatizadas

Furgão gerador, CP



Ep. V

247



S9269007 - CP 92-69 007-7 furgão gerador para carruagens climatizadas "Intercidades IC"

Furgão gerador, CP



Ep. VI

247



S9269009 - CP 92-69 009-3 furgão gerador para carruagens climatizadas



© Nelso Silva

NEW

Conjunto 3 carruagens Schindler



Ep. III
271



Q4 2025

Ilustrações meramente representativas

- S1301** SET 3 pcs - Conjunto composto por 3 carruagens (sistema de freio a vácuo, topos com intercomunicação de folios):
- CP ADtyf 1151 1ª classe salão com furgão
 - CP Ctyf 1212 2ª classe salão
 - CP BDtyf 1301 2ª classe salão com furgão

Conjunto 3 carruagens Schindler



Ep. III
271



Q4 2025

Ilustrações meramente representativas

- S1302** SET 3 pcs - Conjunto composto por 3 carruagens (sistema de freio a vácuo, topos com intercomunicação de folios):
- CP ADtyf 1159 1ª classe salão com furgão
 - CP Ctyf 1236 2ª classe salão
 - CP BDtyf 1301 2ª classe salão com furgão



Conjunto 3 carruagens Schindler



Ep. IV

271



Q4 2025

Ilustrações meramente representativas

S1303

SET 3 pcs

- Conjunto composto por 3 carruagens (sistema de freio a vácuo, topos com intercomunicação de folios):
- CP 81-22 006-8 1ª classe salão com furgão
- CP 21-22 030-1 2ª classe salão
- CP BDtyf 1304 2ª classe salão com furgão

Conjunto 3 carruagens Schindler



Ep. IV

271



Q4 2025

Ilustrações meramente representativas

S1304

SET 3 pcs

- Conjunto composto por 3 carruagens (sistema de freio a vácuo, topos com intercomunicação de folios):
- CP 81-22 004-3 1ª classe salão com furgão
- CP 21-22 037-6 2ª classe salão
- CP 82-22 008-2 2ª classe salão com furgão

NEW

Conjunto 3 carruagens Schindler



Ep. IV
271



Q4 2025

Ilustrações meramente representativas

- S1305** SET 3 pcs - Conjunto composto por 3 carruagens (sistema de freio a ar, topos com intercomunicação de Bourrelets):
- CP 81-22 006-8 1ª classe salão com furgão
 - CP 21-22 029-3 2ª classe salão
 - CP 82-22 009-1 2ª classe salão com furgão

Conjunto 3 carruagens Schindler



Ep. VI
271

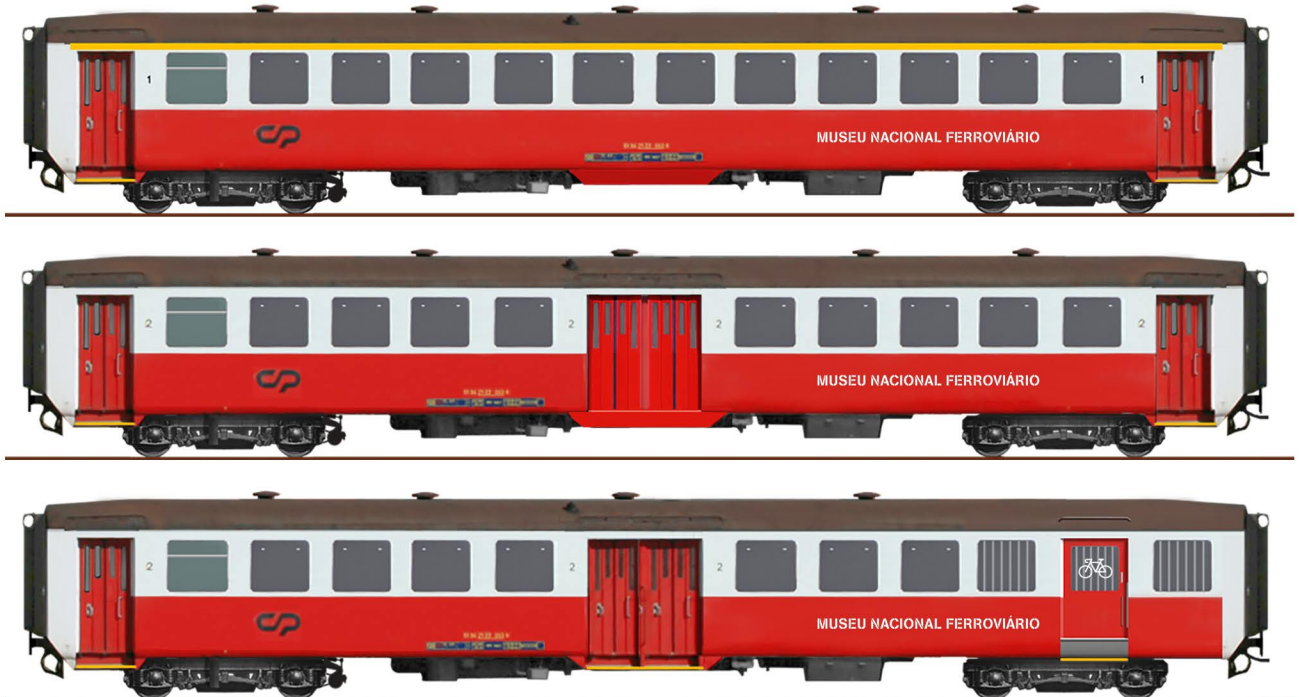

Q4 2025

Ilustrações meramente representativas

- S1306** SET 3 pcs - Conjunto composto por 3 carruagens (sistema de freio a vácuo, topos com intercomunicação de foles):
- CP 19-22 040-4 1ª classe salão
 - CP 21-22 033-5 2ª classe salão
 - CP 82-22 009-1 2ª classe salão com furgão



Conjunto 2 carruagens Schindler



Ep. III

271



S1101

SET 2 pcs

- Conjunto composto por 2 carruagens (sistema de freio a vácuo, topos com intercomunicação de foles):

- CP Ctyf 1201 3ª classe salão
- CP Btyf 1105 2ª classe salão

Conjunto 3 carruagens Schindler



Ep. III

271



S1102

SET 3 pcs

- Conjunto composto por 3 carruagens (sistema de freio a vácuo, topos com intercomunicação de foles):

- CP Ctyf 1240 2ª classe salão
- CP Ctyf 1221 2ª classe salão
- CP Asyf 1103 1ª classe salão

Conjunto 3 carruagens Schindler



Ep. IV

271



S1103

SET 3 pcs

- Conjunto composto por 3 carruagens (sistema de freio a vácuo, topos com intercomunicação de foles):
- CP Ctyf 1224 2ª classe salão
- CP Ctyf 1230 2ª classe salão
- CP Asyf 1108 1ª classe salão

Conjunto 3 carruagens Schindler



Ep. IV

271



S1104

SET 3 pcs

- Conjunto composto por 3 carruagens (sistema de freio a vácuo, topos com intercomunicação de foles):
- CP 21-22 040-0 2ª classe salão
- CP 21-22 019-4 2ª classe salão
- CP 19-22 046-11ª classe salão



Conjunto 3 carruagens Schindler



Ep. IV

271



S1105

SET 3 pcs

- Conjunto composto por 3 carruagens (sistema de freio a ar, topos com intercomunicação de Bourrelets):

- CP 21-22 026-9 2ª classe salão
- CP 21-22 023-6 2ª classe salão
- CP 19-22 042-0 1ª classe salão

Conjunto 3 carruagens Schindler "Vinho do Porto"



Ep. V

271



S1106

SET 3 pcs

- Conjunto composto por 3 carruagens turísticas:

- CP 21-22 023-6 "CAVES SANTA MARTA"
- CP 21-22 028-5 "BARROS/COCKBURN'S"
- CP 19-22 042-0 "TAYLOR'S"

Conjunto 3 carruagens Schindler "Vinho do Porto"



Ep. V

271



S1107

SET 3 pcs

- Conjunto composto por 3 carruagens turísticas:

- CP 19-22 046-1 "SANDEMAN"
- CP 19-22 043-8 "IVDP"
- CP 21-22 030-1 "FERREIRA"

Conjunto 2 carruagens Schindler "Vinho do Porto"



Ep. V

271



S1108

SET 2 pcs

- Conjunto composto por 2 carruagens turísticas:

- CP 19-22 039-6 "POÇAS"
- CP 21-22 018-6 "OFFLEY"



Conjunto 2 carruagens Schindler "Miradouro"



Ep. VI

271



S1109

SET 2 pcs

- Conjunto composto por 2 carruagens (sistema de freio a ar, topos com intercomunicação de *Bourrelets*):
- CP 21-22 030-1 2ª classe salão
- CP 19-22 046-1 1ª classe salão

Conjunto 2 carruagens Schindler "Miradouro"



Ep. VI

271



S1110

SET 2 pcs

- Conjunto composto por 2 carruagens (sistema de freio a ar, topos com intercomunicação de *Bourrelets*):
- CP 21-22 010-1 2ª classe salão
- CP 19-22 043-8 1ª classe salão



© Nelso Silva

H0 1:87

VAGÕES
GÜTERWAGEN
FREIGHT WAGONS







3 piece Laaers set | 3-tlg. Laaers Set



In cooperation with | In kooperatie mit: - Greenbrier Europe

Ep.	VI
	357



© dr_br232



© Nivek



© Anton Kendall

Q4 2026

- S356001** SET 3 pcs - Set consisting of the following 3 Laaers L02A car carrier wagons | Set bestehend aus den folgenden 3 Laaers L02A Autotransportwagen:
- B-MIL 23 88 4356 624-4
 - B-MIL 23 88 4356 641-1
 - B-MIL 23 88 4356 664-3

NEW

3 piece Laaers set | 3-tlg. Laaers Set



In cooperation with | In kooperatie mit: - Greenbrier Europe

Ep.	VI
357	



Q4 2026

- S356002** SET 3 pcs - Set consisting of the following 3 Laaers L02A car carrier wagons | Set bestehend aus den folgenden 3 Laaers L02A Autotransportwagen:
- B-BLG 23 88 4356 044-8
 - B-BLG 23 88 4356 545-4
 - B-BLG 23 88 4356 556-1



3 piece Laaers set | 3-tlg. Laaers Set



In cooperation with | In Kooperation mit: - Greenbrier Europe

Ep.	VI
357	



© Anton Kendall



© Anton Kendall



© Anton Kendall

Q4 2026

S356003 SET 3 pcs - Set consisting of the following 3 Laaers L07A car carrier wagons | Set bestehend aus den folgenden 3 Laaers L07A Autotransportwagen:

- D-TRFSA 25 80 4363 193-0
- D-TRFSA 25 80 4363 189-8
- D-TRFSA 25 80 4363 166-6

NEW

3 piece Laaers set | 3-tlg. Laaers Set



In cooperation with | In Kooperation mit: - Greenbrier Europe

Ep.	VI
	357



Q4 2026

S356004 SET 3 pcs - Set consisting of the following 3 Laaers L08A car carrier wagons | Set bestehend aus den folgenden 3 Laaers L08A Autotransportwagen:

- D-TOUAX 27 80 4371 838-8
- D-TOUAX 27 80 4371 776-0
- D-TOUAX 27 80 4371 809-9



3 piece Laaers set | 3-tlg. Laaers Set



In cooperation with | In Kooperation mit: - Greenbrier Europe

Ep.	VI
	357



© Daniel Mathis



© Olek Pacula



© Olek Pacula

Q4 2026

S356005 SET 3 pcs

- Set consisting of the following 3 Laaers L08A car carrier wagons | Set bestehend aus den folgenden 3 Laaers L08A Autotransportwagen:
- D-ARS 23 80 4371 011-6
- D-ARS 23 80 4371 060-3
- D-ARS 23 80 4371 062-9

NEW

FREIGHT WAGONS
H0

3 piece Tanpps set | 3-tlg. Tanpps Set



In cooperation with | In Kooperation mit: - Wascosa AG
- K+S AG

Ep. VI
567



Q2 2025
S659001

SET 3 pcs

- Set consisting of the following 3 Tanpps hopper wagons |
| Set bestehend aus den folgenden 3 Tanpps Schüttgutwagen:
 - CH-WASCO 33 85 0659 000-3
 - CH-WASCO 33 85 0659 001-1
 - CH-WASCO 33 85 0659 137-3



3 piece Tanpps set | 3-tlg. Tanpps Set



In cooperation with | In Kooperation mit: - Wascosa AG
- K+S AG

Ep. VI
567



Q2 2025
S659002

SET 3 pcs

- Set consisting of the following 3 Tanpps hopper wagons |
- | Set bestehend aus den folgenden 3 Tanpps Schüttgutwagen:
- CH-WASCO 33 85 0659 351-0
- CH-WASCO 33 85 0659 283-5
- CH-WASCO 33 85 0659 375-9



NEW

3 piece Tanpps set | 3-tlg. Tanpps Set



Exclusive 3 pcs. set for | Exklusives 3-tlg. Set für:



In cooperation with | In Kooperation mit: - Wascosa AG
- K+S AG

Ep.	VI
	567



Q2 2025

197267 SET 3 pcs

- Set consisting of the following 3 Tanpps hopper wagons |
- | Set bestehend aus den folgenden 3 Tanpps Schüttgutwagen:
- CH-WASCO 33 85 0659 153-0
- CH-WASCO 33 85 0659 403-9
- CH-WASCO 33 85 0659 059-9





3 piece Zacns set | 3-tlg. Zacns Set



In cooperation with | In Kooperation mit: - BSAS EisenbahnVerkehrs GmbH & Co. KG- Feldbinder Spezialfahrzeugwerke GmbH
- M.A.D. Logistik GmbH - Erwin Kastner



Ep. VI
543



- S783901** SET 3 pcs - Set consisting of the following 3 Zacns tank wagons | Set bestehend aus den folgenden 3 Zacns Kesselwagen:
- D-BSAS 37 80 7839 202-4 "BEAR"
 - D-BSAS 37 80 7839 228-9 "GRAND DANOIS"
 - D-BSAS 37 80 7839 220-6 "DOLPHIN"

NEW RUN

FREIGHT WAGONS
H0

3 piece Zacns set | 3-tlg. Zacns Set



In cooperation with | In Kooperation mit: - BSAS Eisenbahnverkehrs GmbH & Co. KG- Feldbinder Spezialfahrzeugwerke GmbH
- M.A.D. Logistik GmbH - Erwin Kastner

Erwin Kastner
ELKASTNER

Ep.	VI
543	



S783902 SET 3 pcs - Set consisting of the following 3 Zacns tank wagons | Set bestehend aus den folgenden 3 Zacns Kesselwagen :

- D-BSAS 37 80 7839 995-4 "ZEBRA"
- D-BSAS 37 80 7839 208-1 "ELEPHANT"
- D-BSAS 37 80 7839 232-1 "PANTHER"



3 piece Zacns set | 3-tlg. Zacns Set



In cooperation with | In Kooperation mit: - BSAS EisenbahnVerkehrs GmbH & Co. KG- Feldbinder Spezialfahrzeugwerke GmbH
- M.A.D. Logistik GmbH - Erwin Kastner



Ep.	VI
	543



- S783903** SET 3 pcs - Set consisting of the following 3 Zacns tank wagons | Set bestehend aus den folgenden 3 Zacns Kesselwagen:
- D-BSAS 37 80 7839 206-5 "PIKE FISH"
 - D-BSAS 37 80 7839 209-9 "TIGER"
 - D-BSAS 37 80 7839 238-8 "GORILA"

NEW RUN

FREIGHT WAGONS
H0

3 piece Zacns set | 3-tlg. Zacns Set



In cooperation with | In kooperatie mit: - BSAS Eisenbahnverkehrs GmbH & Co. KG- Feldbinder Spezialfahrzeugwerke GmbH
- M.A.D. Logistik GmbH - Erwin Kastner

Erwin Kastner
KASTNER

Ep. VI
543



S783904 SET 3 pcs - Set consisting of the following 3 Zacns tank wagons | Set bestehend aus den folgenden 3 Zacns Kesselwagen :
- D-BSAS 37 80 7839 210-7 "HAWK"
- D-BSAS 37 80 7839 236-2 "LION"
- D-BSAS 37 80 7839 229-7 "RHINO"



3 piece Zacns set | 3-tlg. Zacns Set



In cooperation with | In Kooperation mit: - BSAS EisenbahnVerkehrs GmbH & Co. KG- Feldbinder Spezialfahrzeugwerke GmbH
- M.A.D. Logistik GmbH - Erwin Kastner

Erwin Kastner
KASTNER

Ep. VI
543



- S783905** SET 3 pcs - Set consisting of the following 3 Zacns tank wagons | Set bestehend aus den folgenden 3 Zacns Kesselwagen :
- D-BSAS 37 80 7839 207-3 "MAD BSAS ELP"
 - D-BSAS 37 80 7839 245-3 "ZUG:KUNFT"
 - D-BSAS 37 80 7839 204-0 "ZUG:KUNFT"

NEW

3 piece Sgrrs 80' set | 3-tlg. Sgrrs 80' set



In cooperation with | In Kooperation mit: - Innofreight Solutions GmbH

Ep. VI
918

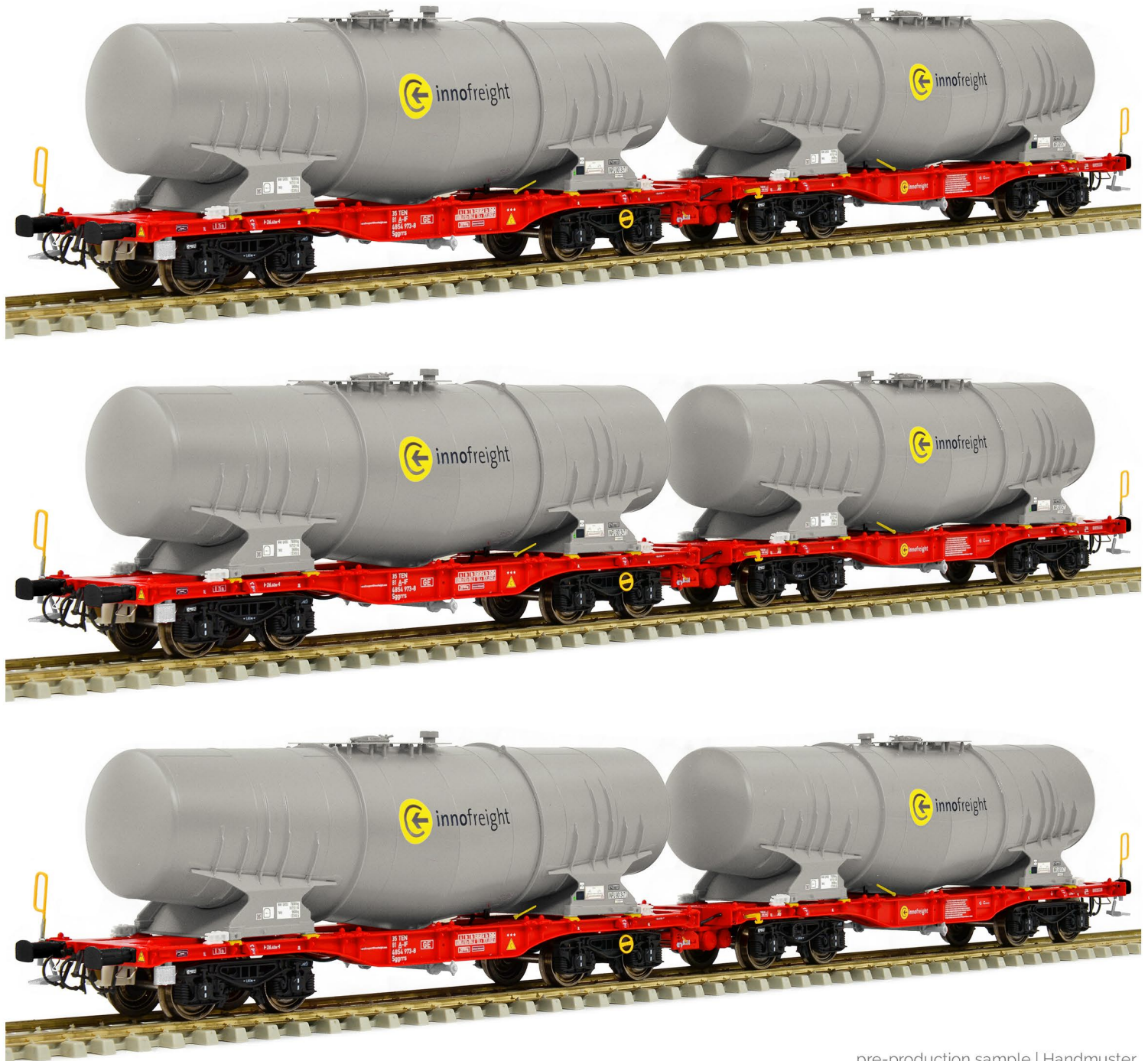

pre-production sample | Handmuster

Q3 2025

S854001 SET 3 pcs

- Set consisting of 3 Sgrrs 80' with SurfaceWaterTanks | Set bestehend aus 3 Sgrrs 80' mit SurfaceWaterTanks:
- A-IF 35 81 4854 874-8 - A-IF 35 81 4854 809-4 - A-IF 35 81 4854 806-0

S854002 SET 3 pcs

- Set consisting of 3 Sgrrs 80' with SurfaceWaterTanks | Set bestehend aus 3 Sgrrs 80' mit SurfaceWaterTanks:
- A-IF 35 81 4854 801-1 - A-IF 35 81 4854 909-2 - A-IF 35 81 4854 864-9



3 piece Sgrrs 80' set | 3-tlg. Sgrrs 80' set



In cooperation with | In Kooperation mit: - Innofreight Solutions GmbH

Ep.	VI
	918



pre-production sample | Handmuster

Q3 2025		
S854003	SET 3 pcs	- Set consisting of 3 Sgrrs 80' with SurfaceWaterTanks Set bestehend aus 3 Sgrrs 80' mit SurfaceWaterTanks: - A-IF 35 81 4854 973-8 - A-IF 35 81 4854 970-4 - A-IF 35 81 4854 968-8
S854004	SET 3 pcs	- Set consisting of 3 Sgrrs 80' with SurfaceWaterTanks Set bestehend aus 3 Sgrrs 80' mit SurfaceWaterTanks: - A-IF 35 81 4854 978-7 - A-IF 35 81 4854 971-2 - A-IF 35 81 4854 967-0

3 piece Sgrrs 80' set | 3-tlg. Sgrrs 80' set



In cooperation with | In Kooperation mit: - InnoFreight Solutions GmbH

Ep.	VI
	918



Q3 2025

S854005

SET 3 pcs

- Set consisting of 3 Sgrrs 80' with 40' HC containers | Set bestehend aus 3 Sgrrs 80' mit 40' HC container:
- A-SKBIN 35 81 4851 151-4 Load | Beladung: 40' HC "MSC" container + 40' HC "MSC" container
 - A-SKBIN 35 81 4851 150-6 Load | Beladung: 40' HC "MSC Florens" container + 40' HC "TRITON" container
 - A-SKBIN 35 81 4851 149-8 Load | Beladung: 40' HC "MSC" container + 40' HC "DONG FANG" container



3 piece Sgrrs 80' set | 3-tlg. Sgrrs 80' set



In cooperation with | In Kooperation mit: - Innofreight Solutions GmbH

Ep.	VI
	918



© Volker Stöckmann



© Volker Stöckmann



© Volker Stöckmann

Q3 2025

S854006 SET 3 pcs

- Set consisting of 3 Sgrrs 80' with 40' HC containers | Set bestehend aus 3 Sgrrs 80' mit 40' HC container:
- A-SKBIN 35 81 4851 152-2 Load | Beladung: 40' HC "MSC" container + 40' HC "MSC" container
- A-SKBIN 35 81 4851 155-5 Load | Beladung: 40' HC "Florens" container + 40' HC "MSC Florens" container
- A-SKBIN 35 81 4851 156-3 Load | Beladung: 40' HC "MSC" container + 40' HC "TRITON" container



© Erik de Zeeuw



© m_trains



3 piece Sggmrrs 90' set | 3-tlg. Sggmrrs 90' set



In cooperation with | In Kooperation mit: - Innofreight Solutions GmbH

Ep.	VI
	1023



© Innofreight



© Innofreight



© Innofreight

Q4 2026

- S4657001** SET 3 pcs - Set consisting of 3 Smart GigaWood Round & Sawn Sggmrrs 90' wagons | Set bestehend aus 3 Smart GigaWood Round & Sawn Sggmrrs 90' Doppel Holztransportwagen:
- A-IF 35 81 4657 598-2
 - A-IF 35 81 4657 615-4
 - A-IF 35 81 4657 619-6

NEW

3 piece Sggmrrs 90' set | 3-tlg. Sggmrrs 90' set



In cooperation with | In Kooperation mit: - InnoFreight Solutions GmbH

Ep.	VI
1023	



Q4 2026

- S4657002** SET 3 pcs - Set consisting of 3 Smart GigaWood Round & Sawn Sggmrrs 90' wagons | Set bestehend aus 3 Smart GigaWood Round & Sawn Sggmrrs 90' Doppel Holztransportwagen:
- A-IF 35 81 4657 507-3
 - A-IF 35 81 4657 338-3
 - A-IF 35 81 4657 339-1



3 piece Sggmrrs 90' set | 3-tlg. Sggmrrs 90' set



In cooperation with | In Kooperation mit: - Innofreight Solutions GmbH

Ep. VI
1023



Q4 2026

S4657003 SET 3 pcs - Set consisting of 3 Wire Stanchion System Sggmrrs 90' | Set bestehend aus 3 Wire Stanchion System Sggmrrs 90':
- A-IF 35 81 4657 334-2 - A-IF 35 81 4657 335-9 - A-IF 35 81 4657 336-7

S4657004 SET 3 pcs - Set consisting of 3 Wire Stanchion System Sggmrrs 90' | Set bestehend aus 3 Wire Stanchion System Sggmrrs 90':
- A-IF 35 81 4657 337-5 - A-IF 35 81 4657 338-3 - A-IF 35 81 4657 339-1

NEW

3 piece Sggmrrs 90' set | 3-tlg. Sggmrrs 90' set



In cooperation with | In Kooperation mit: - Innofreight Solutions GmbH

Ep.	VI
1023	



Q4 2026

- S4657005** SET 3 pcs - Set consisting of 3 Smart GigaWood Sggmrrs 90' wagons | Set bestehend aus 3 Smart GigaWood Sggmrrs 90' Doppel Holztransportwagen:
- A-IF 35 81 4657 239-3
 - A-IF 35 81 4657 240-1
 - A-IF 35 81 4657 249-2



3 piece Sggmrrs 90' set | 3-tlg. Sggmrrs 90' set



In cooperation with | In Kooperation mit: - Innofreight Solutions GmbH

Ep.	VI
1023	



© André Regenspurger



© André Regenspurger



© André Regenspurger

Q4 2026

- S4657005** SET 3 pcs - Set consisting of 3 Smart GigaWood Sggmrrs 90' wagons | Set bestehend aus 3 Smart GigaWood Sggmrrs 90' Doppel Holztransportwagen:
- A-IF 35 81 4657 201-3
 - A-IF 35 81 4657 202-1
 - A-IF 35 81 4657 339-1

Sggmrrs 90' Smart GigaWood



In cooperation with | In Kooperation mit: - Innofreight Solutions GmbH

Ep.	VI
	341
	SUD2061



S657319 Innofreight articulated double timber transport wagon Sggmrrs | Innofreight Doppel Holztransportwagen Sggmrrs
- A-IF 35 81 4657 319-3

Sggmrrs 90' Smart GigaWood



In cooperation with | In Kooperation mit: - Innofreight Solutions GmbH

Ep.	VI
	341
	SUD2061



S657323 Innofreight articulated double timber transport wagon Sggmrrs | Innofreight Doppel Holztransportwagen Sggmrrs
- A-IF 35 81 4657 323-5

Sggmrrs 90' Smart GigaWood



In cooperation with | In Kooperation mit:
- Innofreight Solutions GmbH

Ep.	VI
	341
	SUD2061



S657325 Innofreight articulated double timber transport wagon Sggmrrs | Innofreight Doppel Holztransportwagen Sggmrrs
- A-IF 35 81 4657 325-0 "500TH Smart GigaWood"



Sggmrrs 90' Smart GigaWood



In cooperation with | In Kooperation mit: - Innofreight Solutions GmbH

Ep.	VI
	341
	SUD2061



S657095 Innofreight articulated double timber transport wagon Sggmrrs | Innofreight Doppel Holztransportwagen Sggmrrs
- A-IF 35 81 4657 095-9

Sggmrrs 90' Smart GigaWood



In cooperation with | In Kooperation mit: - Innofreight Solutions GmbH

Ep.	VI
	341
	SUD2061



S657105 Innofreight articulated double timber transport wagon Sggmrrs | Innofreight Doppel Holztransportwagen Sggmrrs
- A-IF 35 81 4657 105-6

Sggmrrs 90' Smart GigaWood



In cooperation with | In Kooperation mit: - Innofreight Solutions GmbH

Ep.	VI
	341
	SUD2061



S657017 VTG articulated double timber transport wagon Sggmrrs | VTG Doppel Holztransportwagen Sggmrrs
- D-VTG 37 80 4657 017-2

Sggmrrs 90' Smart GigaWood



In cooperation with | In Kooperation mit: - Innofreight Solutions GmbH

Ep.	VI
	341
	SUD2061



S657033 VTG articulated double timber transport wagon Sggmrrs | VTG Doppel Holztransportwagen Sggmrrs
- D-VTG 37 80 4657 033-9

Sggmrrs 90' Smart GigaWood



In cooperation with | In Kooperation mit: - Innofreight Solutions GmbH

Ep.	VI
	341
	SUD2061



S657059 VTG articulated double timber transport wagon Sggmrrs | VTG Doppel Holztransportwagen Sggmrrs
- D-VTG 37 80 4657 059-4

Sggmrrs 90' Smart GigaWood



In cooperation with | In Kooperation mit: - Innofreight Solutions GmbH

Ep.	VI
	341
	SUD2061



S657028 VTG articulated double timber transport wagon Sggmrrs | VTG Doppel Holztransportwagen Sggmrrs
- D-VTG 37 80 4657 028-9 with SWISS KRONO AG logos | Mit SWISS KRONO AG Logos



Sggmrrs 90' Smart GigaWood



In cooperation with | In Kooperation mit:
- Innofreight Solutions GmbH

Ep.	VI
	341
	SUD2061



S657115 Innofreight articulated double timber transport wagon Sggmrrs | Innofreight Doppel Holztransportwagen Sggmrrs
- A-IF 35 81 4657 115-5 "HLG-Berba"

Sggmrrs 90' Smart GigaWood



In cooperation with | In Kooperation mit:
- Innofreight Solutions GmbH

Ep.	VI
	341
	SUD2061



S657044 Innofreight articulated double timber transport wagon Sggmrrs | Innofreight Doppel Holztransportwagen Sggmrrs
- D-IF 37 80 4657 044-6 "HLG-Berba"

Sggmrrs 90' Smart GigaWood



In cooperation with | In Kooperation mit: - Innofreight Solutions GmbH

Ep.	VI
	341
	SUD2061



S657010 VTG articulated double timber transport wagon Sggmrrs | VTG Doppel Holztransportwagen Sggmrrs
- D-VTG 37 80 4657 010-7

Sggmrrs 90' Smart GigaWood



In cooperation with | In Kooperation mit: - Innofreight Solutions GmbH

Ep.	VI
	341
	SUD2061



S657001 CD Cargo articulated double timber transport wagon Sggmrrs | CD Cargo Doppel Holztransportwagen Sggmrrs
- A-IF 35 81 4657 001-5

Sggmrrs 90' Smart GigaWood



In cooperation with | In Kooperation mit: - Innofreight Solutions GmbH

Ep.	VI
	341
	SUD2061



S657009 CD Cargo articulated double timber transport wagon Sggmrrs | CD Cargo Doppel Holztransportwagen Sggmrrs
- A-IF 35 81 4657 009-0

Sggmrrs 90' Smart GigaWood



In cooperation with | In Kooperation mit: - Innofreight Solutions GmbH

Ep.	VI
	341
	SUD2061



S657111 CD Cargo articulated double timber transport wagon Sggmrrs | CD Cargo Doppel Holztransportwagen Sggmrrs
- A-IF 35 81 4657 010-8



Sggmrrs 90' Smart GigaWood



In cooperation with | In Kooperation mit: - Innofreight Solutions GmbH

Ep.	VI
	341
	SUD2061



S657004 CD Cargo articulated double timber transport wagon Sggmrrs | CD Cargo Doppel Holztransportwagen Sggmrrs
- A-IF 35 81 4657 004-1

Sggmrrs 90' Smart GigaWood

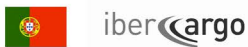

In cooperation with | In Kooperation mit: - Innofreight Solutions GmbH

Ep.	VI
	341
	SUD2061



S657002 Ibercargo articulated double timber transport wagon Sggmrrs | Vagão articulado duplo transp. madeira Ibercargo Sggmrrs
- A-IF 37 81 4657 002-3

Sggmrrs 90' Smart GigaWood

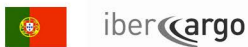

In cooperation with | In Kooperation mit: - Innofreight Solutions GmbH

Ep.	VI
	341
	SUD2061



S657006 Ibercargo articulated double timber transport wagon Sggmrrs | Vagão articulado duplo transp. madeira Ibercargo Sggmrrs
- A-IF 37 81 4657 006-4



© Markus Eisenkolb



Sgnss 60' Container Wagon

+ **HUPAC**

Ep. VI
226



Q2 2026

S4576096

HUPAC Sgnss 60' container wagon | HUPAC Sgnss 60' Containertragwagen
- CH-HUPAC 33 85 4576 096-3 Load | Beladung: 45' swap body "VERSCHEURE"

Sgnss 60' Container Wagon

+ **HUPAC**

Ep. VI
226



Q2 2026

S4576024

HUPAC Sgnss 60' container wagon | HUPAC Sgnss 60' Containertragwagen
- CH-HUPAC 33 85 4576 024-5 Load | Beladung: 45' swap body "Norfolk Line"

Sgnss 60' Container Wagon

+ **wascosa**

Ep. VI
226



Q2 2026

S4552125

Wascosa Sgnss 60' container wagon | Wascosa Sgnss 60' Containertragwagen
- CH-WASCO 33 85 4552 125-8 Load | Beladung: 45' swap body "MOVE Intermodal"

Sgnss 60' Container Wagon

 **wascosa**

Ep. VI

 226

© Jeroen - Wagons

Q2 2026

S4576088

Wascosa Sgnss 60' container wagon | Wascosa Sgnss 60' Containertragwagen
- CH-WASCO 33 85 4552 084-7 Load | Beladung: 45' swap body "Arcese"

Sgnss 60' Container Wagon

 **MFD Rail**

Ep. VI

 226

© Daniel Mathis

Q2 2026

S4565563

MFD Rail Sgnss 60' container wagon | MFD Rail Sgnss 60' Containertragwagen
- D-MFDR 37 80 4565 563-6 Load | Beladung: 45' swap body "Alberti e Santi"

Sgnss 60' Container Wagon

 **MFD Rail**

Ep. VI

 226

© Daniel Mathis

Q2 2026

S4565552

MFD Rail Sgnss 60' container wagon | MFD Rail Sgnss 60' Containertragwagen
- D-MFDR 37 80 4565 552-9 Load | Beladung: 45' swap body "GTS Logistic"



Sgnss 60' Container Wagon



Ep. VI
226



Q2 2026
S4552029

Takargo Rail Sgnss 60' container wagon | Takargo Rail Sgnss 60' Containertragwagen
- P-TK 38 94 4552 029-6 Load | Carga: Innofreight Timber Stanchions

Photomontage

Sgnss 60' Container Wagon



Ep. VI
226



Q2 2026
S4552018

Takargo Rail Sgnss 60' container wagon | Takargo Rail Sgnss 60' Containertragwagen
- P-TK 38 94 4552 018-9 Load | Carga: Innofreight Timber Stanchions

Photomontage

Sgnss 60' Container Wagon



Ep. VI
226



Q2 2026
S4552079

Takargo Rail Sgnss 60' container wagon | Takargo Rail Sgnss 60' Containertragwagen
- P-TK 38 94 4552 079-1 Load | Carga: 45' swap body "Ekol Logistics"

Photomontage

Sgnss 60' Container Wagon



Ep. VI
226



Q2 2026

S4552068

Captrain Sgnss 60' container wagon | Captrain Sgnss 60' Containertragwagen
- E-CTES 38 71 4552 068-1 Load | Carga: Innofreight Timber Stanchions

Photomontage

Sgnss 60' Container Wagon



Ep. VI
226



Q2 2026

S4552034

Captrain Sgnss 60' container wagon | Captrain Sgnss 60' Containertragwagen
- E-CTES 38 71 4552 034-3 Load | Carga: Innofreight Timber Stanchions

Photomontage

Sgnss 60' Container Wagon



Ep. VI
226



Q2 2026

S4552052

Captrain Sgnss 60' container wagon | Captrain Sgnss 60' Containertragwagen
- E-CTES 38 71 4552 052-5 Load | Carga: 45' swap body "Ekol Logistics"

Photomontage



Vagão Rações Valouro Tgpps

Tremonha p/ transporte cereais
24 94 078 9 001-4



Ep. V NEM 352 Ref.: SUD784001

Vagão Rações Valouro Tgpps

Tremonha p/ transporte cereais
24 94 078 9 028-7



Ep. V NEM 352 Ref.: SUD784028

Vagón Renfe R.N. T1

Tolva p/ transporte de cereales
24 71 574 0 095-0



Ep. III NEM 352 Ref.: SUD740095

Vagón Renfe R.N. T1

Tolva p/ transporte de cereales
24 71 574 0 170-1



Ep. III NEM 352 Ref.: SUD740170

Vagón Renfe Metransa Tdgs

Tolva p/ transporte de cereales
24 71 574 0 159-7



Ep. IV NEM 352 Ref.: SUD740159

Vagón Renfe Tgpps

Tolva p/ transporte de cereales
22 71 578 9 040-0



Ep. V NEM 352 Ref.: SUD789040



Vagón Renfe Tgpps

Tolva p/ transporte de cereales
22 71 578 9 099-6



Ep. V NEM 352 Ref.: SUD789099



Wagon CTC Us (Ets. Cadoux)

Wagon p/ transport céréaliier
24 87 093 3 208-9



Ep. III NEM 352 Ref.: SUD933208



Wagon CTC Us (Ets. Cadoux)

Wagon p/ transport céréaliier
24 87 093 3 206-3



Ep. III NEM 352 Ref.: SUD933206



Wagon CTC Us (Ets. Cadoux)

Wagon p/ transport céréaliier
24 87 093 3 203-0



Ep. III NEM 352 Ref.: SUD933203





Vagão coberto, COPAZ



Ep. IV

162



S154014 - CP 154 0 014-4 Vagão Gbkks "COPAZ" (Copaz - Companhia Portuguesa de Azeites S.A.)

Vagão coberto, COPAZ



Ep. IV

162



S154071 - CP 154 0 071-4 Vagão Gbkks "COPAZ" (Copaz - Companhia Portuguesa de Azeites S.A.)

Vagão bagageiro, CP



Ep. IV

162



S941005 - CP 941 1 005-1 Vagão U afecto ao serviço internacional de passageiros (comboios *Sud Expresso* e respectivos desdobramentos)



Vagão gerador, CP



Ep. IV

162



S950003

- CP 950 1 003-6 Vagão U gerador para carruagens climatizadas internacionais (SNCF/RENFE) na Linha da Beira Alta entre 1974 e 1979 aproximadamente.

Vagão gerador, CP



Ep. IV

162



S990002

- CP 990 0 002-3 Vagão U gerador para carruagens climatizadas CP Corail, afectas a serviços *Intercidades* em linhas não eletrificadas, entre 1985 e 1990 aproximadamente.

Vagão gerador, CP



Ep. IV

162



S990003

- CP 990 0 003-1 Vagão U gerador para carruagens climatizadas CP Corail, afectas a serviços *Intercidades* em linhas não eletrificadas, na década de 90.

Vagão gerador, CP



Ep. V

162



S990001

- CP 990 0 001-5 Vagão U gerador para carruagens climatizadas CP Corail, afectas a serviços *Intercidades* em linhas não eletrificadas, na década de 90.



Vagão Ealos, Medway



Ep. VI

162



Q2 2025

S596055 - MED 592 7 055-2 Vagão Medway Ealos, sem carga | No load

Vagão Ealos, Medway



Ep. VI

162



Q2 2025

S596034 - MED 592 7 034-7 Vagão Medway Ealos, sem carga | No load.

Vagão Sgmms, CP



Ep. V

162



Q2 2025

S450028 - CP 450 7 028-0 Vagão CP Sgmms, carregado com 2x tank tainer 20' "AKZO NOBEL"

S0450028 - CP 450 7 028-0 Vagão CP Sgmms, sem carga | No load

Vagão Sgmms, CP



Ep. V

162



Q2 2025

S450021 - CP 450 7 021-5 Vagão CP Sgmms, carregado com 2x tank tainer 20' "HOYER"+"BERTSCHI"

S0450021 - CP 450 7 021-5 Vagão CP Sgmms, sem carga | No load

Vagão Sgmms, CP



Ep. V

162



Q2 2025

S450118

- CP 450 7 118-9 Vagão CP Sgmms, carregado com 1x tank tainer 20' "GCA TAINER"

S0450118

- CP 450 7 118-9 Vagão CP Sgmms, sem carga | No load

Vagão Sgmms, Medway



Ep. VI

162



Q2 2025

S450134

- MED 450 7 134-6 Vagão Medway Sgmms, carregado com 1x tank tainer 20' "Bruhn"

S0450134

- MED 450 7 134-6 Vagão Medway Sgmms, sem carga | No load

Vagão Sgs, CP



Ep. V

162



Q2 2025

S0454079

- CP 454 0 079-2 Vagão CP Sgs, sem carga | No load

Vagão Sgs, CP



Ep. V

162



Q2 2025

S0454084

- CP 454 0 084-2 Vagão CP Sgs, sem carga | No load



Vagão CP Eaos

Versão freio a vácuo
36 94 596 6 015-4



Ep. IV | NEM 352 | Ref.: **S596015** (Sem carga - No load)

Vagão CP Eaos

Versão freio a vácuo
36 94 596 6 022-0



Ep. IV | NEM 352 | Ref.: **S596022** (Sem carga - No load)

Vagão CP Eaos

Versão freio a vácuo
36 94 596 6 021-2



Ep. IV | NEM 352 | Ref.: **S596021** (Sem carga - No load)

Vagão CP Ealos

Versão freio misto
81 94 592 7 104-8



Ep. IV | NEM 352 | Ref.: **S592104** (Sem carga - No load)

Vagão CP Ealos

Versão freio misto
81 94 592 7 003-2



Ep. IV | NEM 352 | Ref.: **S592003** (Sem carga - No load)

Vagão CP Ealos

Versão freio misto
81 94 592 7 216-0



Ep. IV NEM 352 Ref.: **S592216** (Sem carga - No load)

Vagão CP Ealos

Versão transp. beterraba "DAI"
81 94 592 7 209-9



Ep. V NEM 352 Ref.: **S592009** (Sem carga - No load)

Vagão CP Ealos

Versão "DAI", "Para Espanha"
81 94 592 7 274-9



Ep. V NEM 352 Ref.: **S592274** (Sem carga - No load)

Vagão CP Ealos

Versão freio a ar "Para Espanha"
81 94 592 7 005-7



Ep. V NEM 352 Ref.: **S592005** (Sem carga - No load)

Vagão CP Ealos

Versão freio a ar "Para Espanha"
81 94 592 7 010-5



Ep. V NEM 352 Ref.: **S592010** (Sem carga - No load)



Vagão CP Ealos

Versão freio misto
81 94 592 7 066-9



Ep. IV | NEM 352 | Ref.: **S592066** (Sem carga - No load)

Vagão CP Ealos

Versão freio a ar
81 94 592 7 235-0



Ep. V | NEM 352 | Ref.: **S592235** (Sem carga - No load)

Vagão CP Ealos

Versão freio a ar
81 94 592 7 056-0



Ep. VI | NEM 352 | Ref.: **S592056** (Sem carga - No load)

Vagão CP Ealos

Versão freio a ar
81 94 592 7 089-1



Ep. VI | NEM 352 | Ref.: **S592089** (Sem carga - No load)

Vagão Medway Ealos

Versão freio a ar
81 94 592 7 133-7



Ep. VI | NEM 352 | Ref.: **S592133** (Sem carga - No load)

Vagão Medway Ealos

Versão freio a ar
81 94 592 7 146-9



Ep. VI NEM 352 Ref.: **S592146** (Sem carga - No load)

Vagão CP Sgmms

Versão transp. contentores
81 94 450 7 066-0



Ep. V NEM 352 Ref.: **S450066** (Contentor 20' "TIPHOOK")

Vagão CP Sgmms

Versão transp. contentores
81 94 450 7 029-8



Ep. VI NEM 352 Ref.: **S450029** (Contentor 40' HC "BEACON")

Vagão CP Sgmms

Versão transp. contentores
81 94 450 7 079-3



Ep. V NEM 352 Ref.: **S450079** (Contentor 20' "P&O Nedlloyd")



© Nelso Silva



Vagão CP Lyv

Versão freio a vácuo
36 94 444 0 003-9



Ep. III | NEM 352 | Ref.: **S0454003** (Sem carga | No Load)

Vagão CP Lyv

Versão freio a vácuo
36 94 444 0 027-8



Ep. III | NEM 352 | Ref.: **S454027** (2x contentor 20' topo aberto "SADOMAR")

Vagão CP Sgs

Versão freio a vácuo
81 94 454 0 045-0



Ep. IV | NEM 352 | Ref.: **S454045** (2x contentor 20' "RAÇÕES VALOURO") | Ref.: **S0454045** (Sem carga | No load)

Vagão CP Sgs

Versão freio a vácuo
81 94 454 0 026-3



Ep. IV | NEM 352 | Ref.: **S454026** (2x contentor 20' topo aberto "SOCARMAR")

Vagão CP Sgs

Versão freio misto
81 94 454 0 103-0



Ep. IV | NEM 352 | Ref.: **S454103** (2x contentor 20' topo aberto "SOCARMAR")

Vagão CP Sgs

Versão freio misto
81 94 454 0 058-6



Ep. IV | NEM 352 | Ref.: **S454058** (2x contentor 20" "RAÇÕES VALOURO")

Vagão CP Sgs

Versão freio misto "Para Espanha"
81 94 454 0 012-3



Ep. V | NEM 352 | Ref.: **S454012** (2x contentor 20" topo aberto "SOCARMAR / CP") | Ref.: **S0454012** (Sem carga | No load)

Vagão CP Sgs

Versão freio misto "Para Espanha"
81 94 454 0 076-8



Ep. V | NEM 352 | Ref.: **S454076** (2x contentor 20" topo aberto "SADOMAR")

Vagão CP Sgs

Versão sem taipais
81 94 454 0 103-0



Ep. V | NEM 352 | Ref.: **S0454103** (Sem carga | No load)

Vagão CP Sgs

Versão sem taipais
81 94 454 0 016-4



Ep. V | NEM 352 | Ref.: **S454016** (2x contentor 20" "AVIBOM RACÕES VALOURO")



Vagão CP Kbs

Série 333 0
41 94 333 0 015-1



Ep. V NEM 352 Ref.: **S333015**



Vagão CP Kbs

Série 333 0
41 94 333 0 063-1



Ep. V NEM 352 Ref.: **S333063**



Vagão Medway Kbs

Série 333 0
41 94 333 0 018-5



Transporte & Logística

Ep. VI NEM 352 Ref.: **S333018**



Vagão Medway Kbs

Série 333 0
41 94 333 0 023-5



Transporte & Logística

Ep. VI NEM 352 Ref.: **S333023**



© Nelso Silva

Vagão CP Uahs

Transp. de Fuel Óleo
89 94 729 6 001-1



Ref.: **SUD729001** (versão engates Altas - Kadee, NEM 360)

Vagão CP Uahs

Transp. de Fuel Óleo
89 94 729 6 054-1



Ref.: **SUD729054** (versão engates Altas - Kadee, NEM 360)

Vagão CP Zaes - Transição Engates

Transp. de Adubo Líquido
89 94 788 0 068-6



Ref.: **SUD788068** (versão engates mistos - Kadee, NEM 360, NEM362)

Vagão CP Zaes - Transição Engates

Transp. de Fuel Óleo
89 94 788 0 069-4



Ref.: **SUD788069** (versão engates mistos - Kadee, NEM 360, NEM362)

Vagão CP Zaes - Transição Engates

89 94 788 0 074-4



Ref.: **SUD788074** (versão engates mistos - Kadee, NEM 360, NEM362)



Vagão CP Zaes - Transição Engates

89 94 788 0 134-6



Ep. IV 

Ref.: **SUD788134** (versão engates mistos - Kadee, NEM 360, NEM362)

Vagão CP Zaes

Transp. de Nafta

89 94 788 0 018-1



Ep. V 

Ref.: **SUD788018** (versão engates Altas - Kadee, NEM 360)

Vagão CP Zaes

Transp. de Nafta

89 94 788 0 114-8



Ep. V 

Ref.: **SUD788114** (versão engates Altas - Kadee, NEM 360)

Vagão CP Zaes

Transp. de Biodiesel

89 94 788 0 092-6



Ep. V 

Ref.: **SUD788092** (versão engates tensor/batentes - NEM360, NEM 362)

Vagão CP Zaes

Transp. de Biodiesel

89 94 788 0 124-7



Ep. V 

Ref.: **SUD788124** (versão engates tensor/batentes - NEM360, NEM 362)



© Nelso Silva

N1:160

LOCOMOTIVAS
LOCOMOTIVES
LOKOMOTIVEN







EuroDual Locomotive 159 210-4



In cooperation with | In Kooperation mit: - BSAS EisenbahnVerkehrs GmbH & Co. KG
- M.A.D. Logistik GmbH

Ep.	VI
	145
	E24



Q4 2025		
N1592101	DC =	- DC analogic version (1:160 N Scale)
N1592100	=	- DC with Sound (1:160 N Scale)

Design by Gudrun Geiblinger

EuroDual Locomotive 159 209-6



In cooperation with | In Kooperation mit: - BSAS EisenbahnVerkehrs GmbH & Co. KG- M.A.D. Logistik GmbH
- Gudrun Geiblinger Design

Ep.	VI
	145
	E24



Q4 2025		
N1592091	DC =	- DC analogic version (1:160 N Scale)
N1592090	=	- DC with Sound (1:160 N Scale)

Design by Gudrun Geiblinger

NEW

EuroDual Locomotive 159 227-8



In cooperation with | In Kooperation mit: - Erfurter Bahnservice GmbH
- Railcolor Design & OnTrack

Ep.	VI
	145
	E24

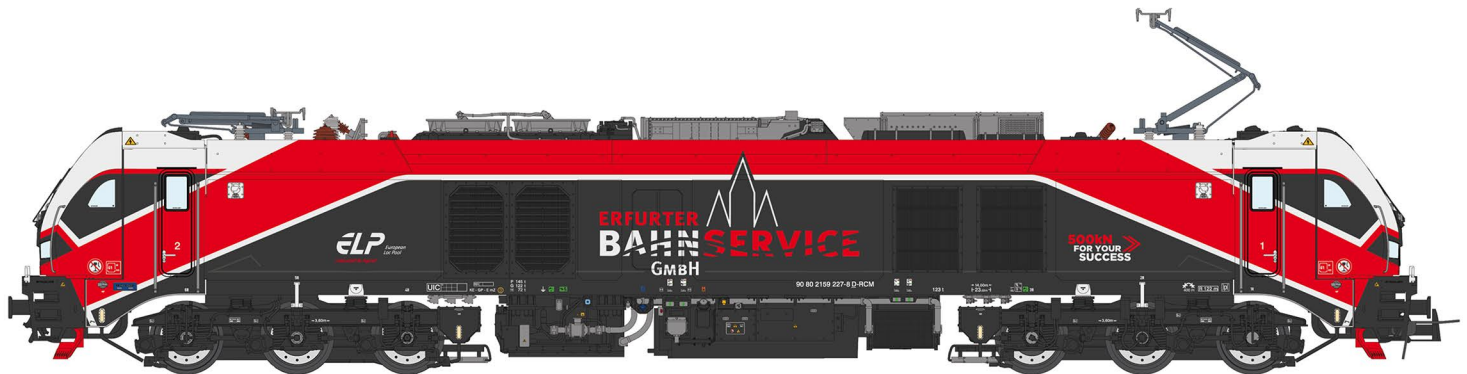

Q4 2025		
N1592271	DC =	- DC analogic version (1:160 N Scale)
N1592270	=	- DC with Sound (1:160 N Scale)

EuroDual Locomotive 159 451-4



In cooperation with | In Kooperation mit: - Erfurter Bahnservice GmbH
- Railcolor Design & OnTrack

Ep.	VI
	145
	E24



Q4 2025		
N1594511	DC =	- DC analogic version (1:160 N Scale)
N1594510	=	- DC with Sound (1:160 N Scale)



EuroDual Locomotive 159 102-4



In cooperation with | In Kooperation mit: ITL Eisenbahngesellschaft - Captrain Deutschland GmbH

Ep.	VI
	145
	E24



Q4 2025			
N1591021	DC =		- DC analogic version (1:160 N Scale)
N1591020	=		- DC with Sound (1:160 N Scale)

EuroDual Locomotive 159 444-9



In cooperation with | In Kooperation mit: - Raildox GmbH & Co. KG

Ep.	VI
	145
	E24



Q4 2025			
N1594441	DC =		- DC analogic version (1:160 N Scale)
N1594440	=		- DC with Sound (1:160 N Scale)

EuroDual Locomotive 159 001-7



In cooperation with | In Kooperation mit: Havelländische Eisenbahn AG

Ep.	VI
	145
	E24



N1590011	DC =	- DC analogic version (1:160 N Scale)
N1590010	=	- DC with Sound (1:160 N Scale)

EuroDual Locomotive 159 003-3



In cooperation with | In Kooperation mit: Havelländische Eisenbahn AG

Ep.	VI
	145
	E24



N1590031	DC =	- DC analogic version (1:160 N Scale)
N1590030	=	- DC with Sound (1:160 N Scale)



EuroDual Locomotive 159 208-8



In cooperation with | In Kooperation mit: - BSAS EisenbahnVerkehrs GmbH & Co. KG- M.A.D. Logistik GmbH
- Gudrun Geiblinger Design

Ep.	VI
	145
	E24



N1592081	DC =	- DC analogic version (1:160 N Scale)
N1592080	=	- DC with Sound (1:160 N Scale)

Design by Gudrun Geiblinger

EuroDual Locomotive 159 101-5



In cooperation with | In Kooperation mit: ITL Eisenbahngesellschaft - Captrain Deutschland GmbH

Ep.	VI
	145
	E24



N1591011	DC =	- DC analogic version (1:160 N Scale)
N1591010	=	- DC with Sound (1:160 N Scale)

EuroDual Locomotive 159 201-3



In cooperation with | In Kooperation mit: Heavy Haul Power International GmbH

Ep.	VI
	145
	E24



N1592011	DC =	- DC analogic version (1:160 N Scale)
N1592010	=	- DC with Sound (1:160 N Scale)

EuroDual Locomotive 159 231-0



In cooperation with | In Kooperation mit: - Eisenbahnen und Verkehrsbetriebe Elbe-Weser GmbH
- Trispel rail-de-sign

Ep.	VI
	145
	E24



N1592311	DC =	- DC analogic version (1:160 N Scale)
N1592310	=	- DC with Sound (1:160 N Scale)



EuroDual Locomotive 159 240-1



DB Cargo

In cooperation with | In Kooperation mit: - DB Cargo AG
- Trispel rail-de-sign

Ep.	VI
	145
	E24



N1592401	DC =	- DC analogic version (1:160 N Scale)
N1592400	=	- DC with Sound (1:160 N Scale)



© Sudexpress archive

NEW

Euro9000 Locomotive 2019 303-7



In cooperation with | In kooperatie mit: - Rail Force One
- Railcolor Design

Ep.	VI
	145
	E24

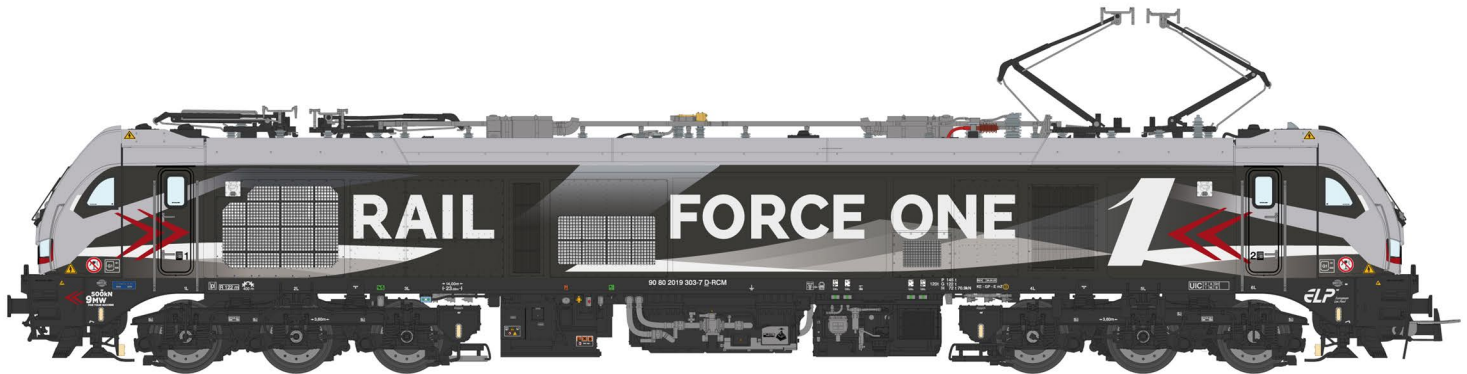

Q1 2026		
N0193031	DC =	- DC analogic version (1:160 N Scale)
N0193030	=	- DC with Sound (1:160 N Scale)

Euro9000 Locomotive 2019 310-2



In cooperation with | In kooperatie mit: - LOKOMOTION Gesellschaft für Schienentraktion mbH
- Railcolor Design

Ep.	VI
	145
	E24

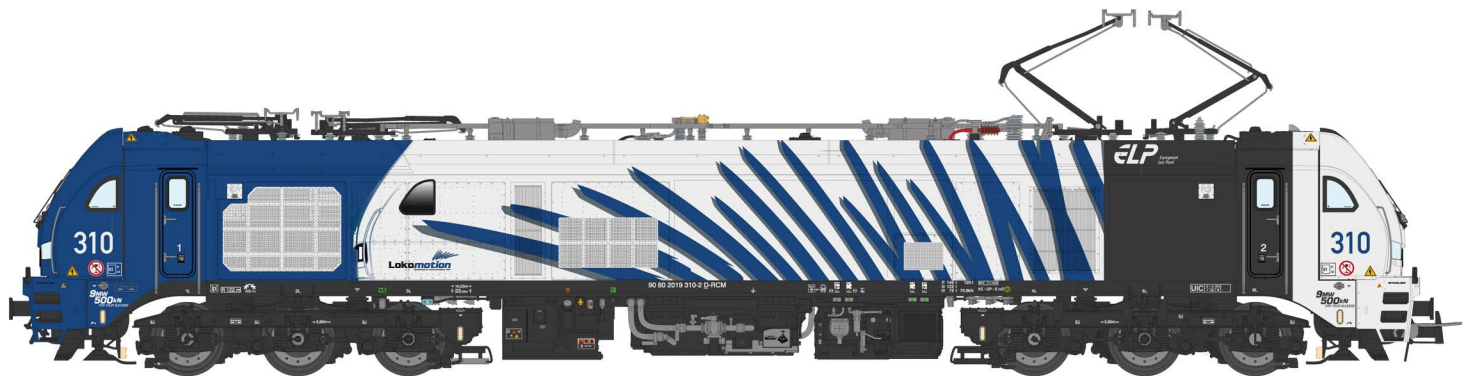

Q1 2026		
N0193101	DC =	- DC analogic version (1:160 N Scale)
N0193100	=	- DC with Sound (1:160 N Scale)



Euro9000 Locomotive 2019 307-8



In cooperation with | In Kooperation mit: - HSL Logistik GmbH
- Mathias Oestreich

Ep.	VI
	145
	E24



Q1 2026			
N0193071	DC =		- DC analogic version (1:160 N Scale)
N0193070	=		- DC with Sound (1:160 N Scale)

Euro9000 Locomotive 2019 314-4



In cooperation with | In Kooperation mit: - HSL Logistik GmbH
- Mathias Oestreich

Ep.	VI
	145
	E24



Q1 2026			
N0193141	DC =		- DC analogic version (1:160 N Scale)
N0193140	=		- DC with Sound (1:160 N Scale)

NEW

Euro9000 Locomotive 2019 305-2



In cooperation with | In Kooperation mit: - RTB Cargo GmbH
- Railcolor Design

Ep.	VI
145	
E24	



Q1 2026		
N0193051	DC =	- DC analogic version (1:160 N Scale)
N0193050	=	- DC with Sound (1:160 N Scale)

Euro9000 Locomotive 2019 311-0



In cooperation with | In Kooperation mit: - RTB Cargo GmbH
- Railcolor Design

Ep.	VI
145	
E24	



Q1 2026		
N0193111	DC =	- DC analogic version (1:160 N Scale)
N0193110	=	- DC with Sound (1:160 N Scale)



Euro9000 Locomotive 2019 318-5



In cooperation with | In Kooperation mit: - railCare AG

Ep.	VI
	145
	E24



Q1 2026		
N0193181	DC =	- DC analogic version (1:160 N Scale)
N0193180	=	- DC with Sound (1:160 N Scale)

Euro9000 Locomotive 2019 309-4



In cooperation with | In Kooperation mit: - BBL LOGISTIK GmbH

Ep.	VI
	145
	E24



Q1 2026		
N0193091	DC =	- DC analogic version (1:160 N Scale)
N0193090	=	- DC with Sound (1:160 N Scale)

Euro6000 Locomotive 6007-5



In cooperation with | En cooperación con | En coopération avec: - Transfesa Logistics S.A. and DB Cargo AG
- Loc&More

Ep.	VI
	145
	E24



Q2 2026

N0060071 DC = - DC analogic version (1:160 N Scale)

N0060070 = - DC with Sound (1:160 N Scale)

Euro6000 Locomotive 6006-7



In cooperation with | En cooperación con | En coopération avec: - Transfesa Logistics S.A. and DB Cargo AG

Ep.	VI
	145
	E24



Q2 2026

N0060061 DC = - DC analogic version (1:160 N Scale)

N0060060 = - DC with Sound (1:160 N Scale)



Euro6000 Locomotive 6001-8



In cooperation with | En cooperación con | En coopération avec: - Captrain España
- Captrain France

Ep.	VI
	145
	E24



Q2 2026		
N0060011	DC =	- DC analogic version (1:160 N Scale)
N0060010	=	- DC with Sound (1:160 N Scale)

Euro6000 Locomotive 256 007-7



In cooperation with | En cooperación con: - Captrain España

Ep.	VI
	145
	E24



Q2 2026		
N2560071	DC =	- DC analogic version (1:160 N Scale)
N2560070	=	- DC with Sound (1:160 N Scale)

NEW

Euro6000 Locomotive 256 104-2



In cooperation with | En cooperación con: - Renfe Mercancías

Ep.	VI
	145
	E24



Q2 2026		
N2561041	DC =	- DC analogic version (1:160 N Scale)
N2561040	=	- DC with Sound (1:160 N Scale)

Euro6000 Locomotive 256 004-4



In cooperation with | En cooperación con: - Continental Rail S.A.

Ep.	VI
	145
	E24



Q2 2026		
N2560041	DC =	- DC analogic version (1:160 N Scale)
N2560040	=	- DC with Sound (1:160 N Scale)



Euro6000 Locomotive 256 017-6



In cooperation with | Em cooperação com | En cooperación con: - Medway Iberia S.A.
- Boa Mistura

Ep.	VI
	145
	E24

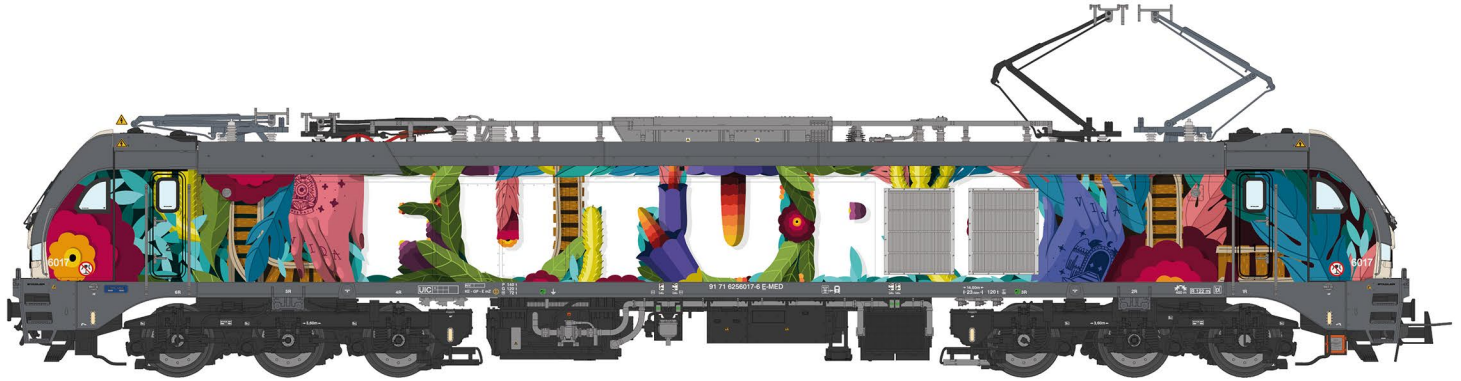

Q2 2026		
N2560171	DC =	- DC analogic version (1:160 N Scale)
N2560170	=	- DC with Sound (1:160 N Scale)

Euro6000 Locomotive 256 201-6



In cooperation with | Em cooperação com | En cooperación con: - Medway Iberia S.A.

Ep.	VI
	145
	E24



Q2 2026		
N2562011	DC =	- DC analogic version (1:160 N Scale)
N2562010	=	- DC with Sound (1:160 N Scale)

NEW

Euro4000 Locomotive E4028



In cooperation with | En coopération avec: - Captrain France

Ep.	VI
145	
NEM651	

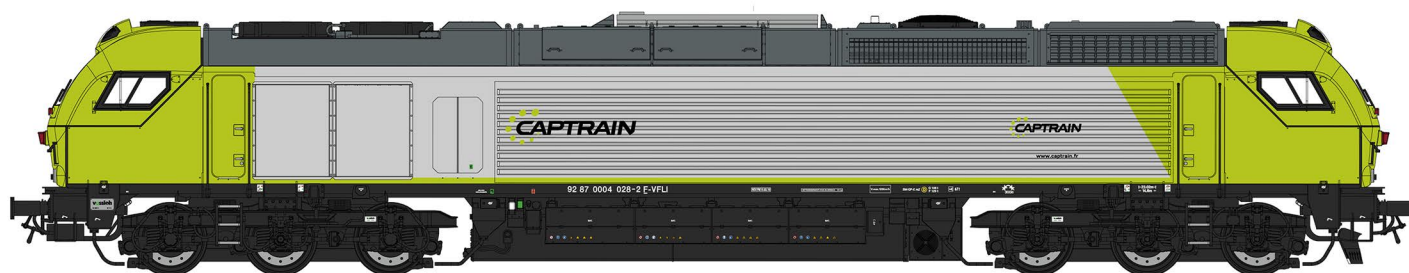

Q4 2025
N0040281

DC =

- DC analogic version (1:160 N scale)
 New "Captrain" livery that replaced the old "VFLI" livery.
 Nouvelle livrée "Captrain" qui a remplacé l'ancienne livrée "VFLI".

Euro4000 Locomotive E4024



In cooperation with | In Kooperation mit: - Europorte

Ep.	VI
145	
NEM651	



Q4 2025
N0040241

DC =

- DC analogic version (1:160 N scale)
 Special "oleo100" livery
 Livrée spéciale "oleo100"
 Sonderlackierung "oleo100"



Diesel Locomotive 335.033, "Matilde"



MEDWAY
Transporte & Logística

In cooperation with | Em cooperação com: - Medway Iberia

Ep.	VI
145	
NEM651	



Q4 2025
N3350331

DC =

- DC analogic version (1:160 N scale)

Medway E 5033 locomotive baptized as "Matilde" with modernized LED lightmarkers
Locomotiva Medway E 5033 batizada de "Matilde" com farolins LED modernizados

Diesel Locomotive 335.003



CAPTRAIN

Ep.	VI
145	
NEM651	

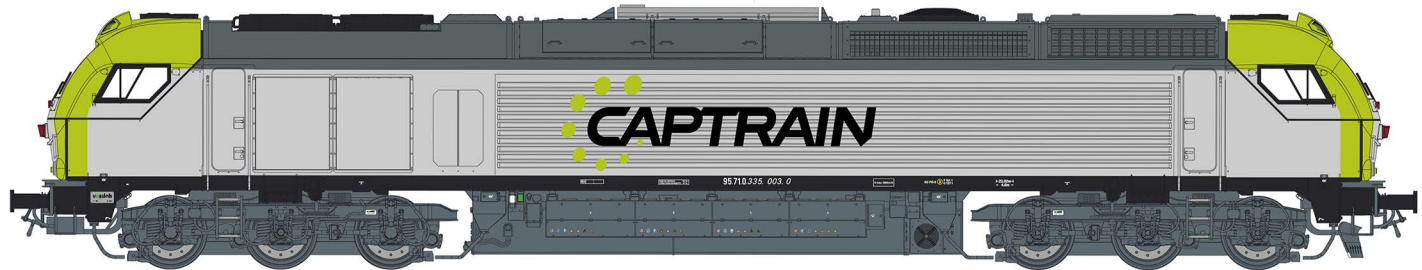
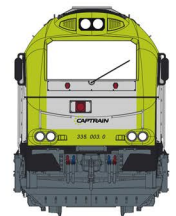

Q4 2025
N3350031

DC =

- DC analogic version (1:160 N scale)

New "Captrain" livery that replaced the old "Comsa Rail" livery.
Nueva librea "Captrain" que reemplazó la antigua librea "Comsa Rail".

NEW

Diesel Locomotive 335.020



In cooperation with | Em cooperação com: - Captrain España
- Ibercarga Rail, S.A. (Joint Venture Takargo Rail & Captrain España)

Ep.	VI
145	
NEM651	

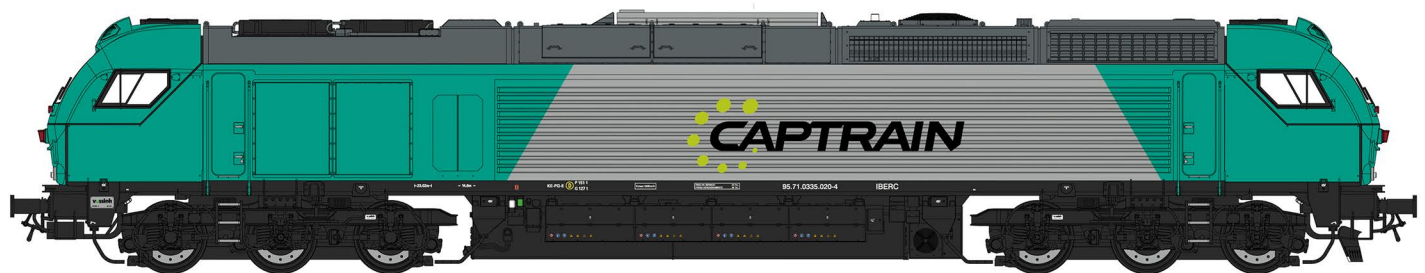
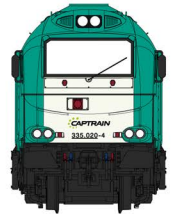

Q4 2025
N3350201

DC =

- DC analogic version (1:160 N scale)
Alpha Trains locomotive hired to Captrain España/Ibercarga
Locomotiva da Alpha Trains alugada a Captrain España/Ibercarga

Diesel Locomotive 6002



In cooperation with | Em cooperação com: - Takargo Rail S.A.

Ep.	VI
145	
NEM651	



Q4 2025
N0060021

DC =

- DC analogic version (1:160 N scale)
Takargo Euro4000 locomotive with modernized LED lightmarkers.
Locomotiva Takargo Euro4000 com farolins LED modernizados.

N 1:160

VAGÖES
FREIGHT WAGONS
GÜTERWAGEN







Sggmrrs 90' Smart GigaWood



In cooperation with | In Kooperation mit: - Innofreight Solutions GmbH

Ep.	VI
	185



Q2 2025

N657095 Innofreight articulated double timber transport wagon Sggmrrs | Innofreight Doppel Holztransportwagen Sggmrrs
- A-IF 35 81 4657 095-9

Sggmrrs 90' Smart GigaWood



In cooperation with | In Kooperation mit: - Innofreight Solutions GmbH

Ep.	VI
	185



Q2 2025

N657105 Innofreight articulated double timber transport wagon Sggmrrs | Innofreight Doppel Holztransportwagen Sggmrrs
- A-IF 35 81 4657 105-6

Sggmrrs 90' Smart GigaWood



In cooperation with | In Kooperation mit: - Innofreight Solutions GmbH

Ep.	VI
	185



Q2 2025

N657010 Innofreight articulated double timber transport wagon Sggmrrs | Innofreight Doppel Holztransportwagen Sggmrrs
- A-IF 37 80 4657 010-7

Sggmrrs 90' Smart GigaWood



In cooperation with | In Kooperation mit: - Innofreight Solutions GmbH

Ep.	VI
	185



Q2 2025

N657033

Innofreight articulated double timber transport wagon Sggmrrs | Innofreight Doppel Holztransportwagen Sggmrrs
- D-VTG 37 80 4657 033-9

Sggmrrs 90' Smart GigaWood



In cooperation with | In Kooperation mit: - Innofreight Solutions GmbH

Ep.	VI
	185



Q2 2025

N657059

Innofreight articulated double timber transport wagon Sggmrrs | Innofreight Doppel Holztransportwagen Sggmrrs
- D-VTG 37 80 4657 059-4

Sggmrrs 90' Smart GigaWood



In cooperation with | In Kooperation mit: - Innofreight Solutions GmbH

Ep.	VI
	185



Q2 2025

N657001

Innofreight articulated double timber transport wagon Sggmrrs | Innofreight Doppel Holztransportwagen Sggmrrs
- A-IF 35 81 4657 001-5



Sggmrrs 90' Smart GigaWood



In cooperation with | In Kooperation mit: - Innofreight Solutions GmbH

Ep.	VI
	185



Q2 2025

N657009 Innofreight articulated double timber transport wagon Sggmrrs | Innofreight Doppel Holztransportwagen Sggmrrs
- A-IF 35 81 4657 009-0

Sggmrrs 90' Smart GigaWood



In cooperation with | In Kooperation mit: - Innofreight Solutions GmbH

Ep.	VI
	185



Q2 2025

N657319 Innofreight articulated double timber transport wagon Sggmrrs | Innofreight Doppel Holztransportwagen Sggmrrs
- A-IF 35 81 4657 319-3

Sggmrrs 90' Smart GigaWood



In cooperation with | In Kooperation mit: - Innofreight Solutions GmbH

Ep.	VI
	185



Q2 2025

N657323 Innofreight articulated double timber transport wagon Sggmrrs | Innofreight Doppel Holztransportwagen Sggmrrs
- A-IF 35 81 4657 323-5

NEW

Sgmmrrs 90' Smart GigaWood



In cooperation with | In Kooperation mit: - Innofreight Solutions GmbH

Ep.	VI
	185



Q2 2025

N657002 Innofreight articulated double timber transport wagon Sgmmrrs | Innofreight Doppel Holztransportwagen Sgmmrrs
- A-IF 37 81 4657 002-3

Sgmmrrs 90' Smart GigaWood



In cooperation with | In Kooperation mit: - Innofreight Solutions GmbH

Ep.	VI
	185



Q2 2025

N657006 Innofreight articulated double timber transport wagon Sgmmrrs | Innofreight Doppel Holztransportwagen Sgmmrrs
- A-IF 37 81 4657 006-4



© Nelso Silva



2 piece Sggmrrs set | 2-tlg. Sggmrrs Set

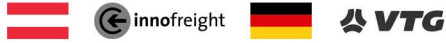

Exclusive 2 pcs. set for | Exklusives 2-tlg. Set für:



In cooperation with | In Kooperation mit: - Innofreight Solutions GmbH

Ep. VI
370



Q2 2025

- Set consisting of the following 2 Sggmrrs wagons | Set bestehend aus den folgenden 2 Sggmrrs Wagen:

N657888

- A-IF 35 81 4657 167-6

SET 2 pcs

- D-VTG 37 80 4657 028-9 with SWISS KRONO AG logos | Mit SWISS KRONO AG Logos

2 piece Sggmrrs set | 2-tlg. Sggmrrs Set



Exclusive 2 pcs. set for | Exklusives 2-tlg. Set für:



In cooperation with | In Kooperation mit: - Innofreight Solutions GmbH

Ep. VI
370



Q2 2025

- Set consisting of the following 2 Sggmrrs wagons | Set bestehend aus den folgenden 2 Sggmrrs Wagen:

N657999

- A-IF 35 81 4657 320-1

SET 2 pcs

- A-IF 35 81 4657 325-0 with | mit: "500TH Smart GigaWood" logos



© Pedro Almeida



© Stefan Schulthess

TT 1:120
LOCOMOTIVAS
LOCOMOTIVES
LOKOMOTIVEN







EuroDual Locomotive 159 001-7



Ep.	VI
	193
	E24
	FAN MOTOR



Q4 2025

H0 photo as placeholder | H0-Foto als Platzhalter

T1590011	DC =	- DC analogic version (1:120 TT Scale)
T1590010	=	- DC with Sound + Panto (Premium line version 1:120 TT Scale)

EuroDual Locomotive 159 003-3



In cooperation with | In Kooperation mit: - Havelländische Eisenbahn AG

Ep.	VI
	193
	E24
	FAN MOTOR



Q4 2025

H0 photo as placeholder | H0-Foto als Platzhalter

T1590031	DC =	- DC analogic version (1:120 TT Scale)
T1590030	=	- DC with Sound + Panto (Premium line version 1:120 TT Scale)

EuroDual Locomotive 159 208-8



In cooperation with | In Kooperation mit: - BSAS Eisenbahnverkehrs GmbH & Co. KG
- M.A.D. Logistik GmbH
- Gudrun Geiblinger Design

Ep.	VI
	193
	E24
	FAN MOTOR



Q4 2025

H0 photo as placeholder | H0-Foto als Platzhalter

T1592081	DC =	- DC analogic version (1:120 TT Scale)
T1592080	=	- DC with Sound + Panto (Premium line version 1:120 TT Scale)

Design by Gudrun Geiblinger

EuroDual Locomotive 159 101-5



In cooperation with | In Kooperation mit: ITL Eisenbahngesellschaft - Captrain Deutschland GmbH

Ep.	VI
	193
	E24
	FAN MOTOR



Q4 2025

H0 photo as placeholder | H0-Foto als Platzhalter

T1591011	DC =	- DC analogic version (1:120 TT Scale)
T1591010	=	- DC with Sound + Panto (Premium line version 1:120 TT Scale)



EuroDual Locomotive 159 201-3



In cooperation with | In Kooperation mit: - Heavy Haul Power International GmbH

Ep.	VI
	193
	E24
	FAN MOTOR



Q4 2025

H0 photo as placeholder | H0-Foto als Platzhalter

T1592011	DC =	- DC analogic version (1:120 TT Scale)
T1592010	=	- DC with Sound + Panto (Premium line version 1:120 TT Scale)

EuroDual Locomotive 159 227-8



In cooperation with | I samarbete med: - Erfurter Bahnservice GmbH
- Railcolor Design

Ep.	VI
	193
	E24
	FAN MOTOR



Q4 2025

H0 photo as placeholder | H0-Foto als Platzhalter

T1592271	DC =	- DC analogic version (1:120 TT Scale)
T1592270	=	- DC with Sound + Panto (Premium line version 1:120 TT Scale)

EuroDual Locomotive 159 240-1



In cooperation with | In Kooperation mit: - DB Cargo AG
- Trispel rail-de-sign

Ep.	VI
	193
	E24
	FAN MOTOR



Q4 2025

H0 photo as placeholder | H0-Foto als Platzhalter

T1592401	DC =	- DC analogic version (1:120 TT Scale)
T1592400	=	- DC with Sound + Panto (Premium line version 1:120 TT Scale)

EuroDual Locomotive 159 102-3



In cooperation with | In Kooperation mit: ITL - Captrain Deutschland GmbH

Exclusive for | Exklusiv für:

elriwa[®]
Ihr Fachhandel für
Modellbahnen und Zubehör

Ep.	VI
	193
	E24
	FAN MOTOR



Q4 2025

H0 photo as placeholder | H0-Foto als Platzhalter

T1591021	DC =	- DC analogic version (1:120 TT Scale)
T1591020	=	- DC with Sound + Panto (Premium line version 1:120 TT Scale)



Euro9000 Locomotive 2019 303-7



In cooperation with | In Kooperation mit: - Rail Force One
- Railcolor Design

Ep.	VI
	193
	E24



Q2 2026

H0 photo as placeholder | H0-Foto als Platzhalter

T0193031	DC =	- DC analogic version (1:120 TT Scale)
T0193030	=	- DC with Sound + Panto (Premium line version 1:120 TT Scale)

Euro9000 Locomotive 2019 310-2



In cooperation with | In Kooperation mit: - LOKOMOTION Gesellschaft für Schienentraktion mbH
- Railcolor Design

Ep.	VI
	193
	E24



Q2 2026

H0 photo as placeholder | H0-Foto als Platzhalter

T0193101	DC =	- DC analogic version (1:120 TT Scale)
T0193100	=	- DC with Sound + Panto (Premium line version 1:120 TT Scale)

Euro9000 Locomotive 2019 307-8



In cooperation with | In Kooperation mit: - HSL Logistik GmbH
- Mathias Oestreich

Ep.	VI
	193
	E24



Q2 2026

H0 photo as placeholder | H0-Foto als Platzhalter

T0193071	DC =	- DC analogic version (1:120 TT Scale)
T0193070	=	- DC with Sound + Panto (Premium line version 1:120 TT Scale)

Euro9000 Locomotive 2019 314-4



In cooperation with | In Kooperation mit: - HSL Logistik GmbH
- Mathias Oestreich

Ep.	VI
	193
	E24



Q2 2026

H0 photo as placeholder | H0-Foto als Platzhalter

T0193141	DC =	- DC analogic version (1:120 TT Scale)
T0193140	=	- DC with Sound + Panto (Premium line version 1:120 TT Scale)



Euro9000 Locomotive 2019 305-2



In cooperation with | In Kooperation mit: - RTB Cargo GmbH
- Railcolor Design

Ep.	VI
	193
	E24



Q2 2026

H0 photo as placeholder | H0-Foto als Platzhalter

T0193051	DC =	- DC analogic version (1:120 TT Scale)
T0193050	=	- DC with Sound + Panto (Premium line version 1:120 TT Scale)

Euro9000 Locomotive 2019 311-0



In cooperation with | In Kooperation mit: - RTB Cargo GmbH
- Railcolor Design

Ep.	VI
	193
	E24



Q2 2026

H0 photo as placeholder | H0-Foto als Platzhalter

T0193111	DC =	- DC analogic version (1:120 TT Scale)
T0193110	=	- DC with Sound + Panto (Premium line version 1:120 TT Scale)

Euro9000 Locomotive 2019 318-5



In cooperation with | In Kooperation mit: - railCare AG

Ep.	VI
	193
	E24



Q2 2026

H0 photo as placeholder | H0-Foto als Platzhalter

T0193181	DC =	- DC analogic version (1:120 TT Scale)
T0193180	=	- DC with Sound + Panto (Premium line version 1:120 TT Scale)

Euro9000 Locomotive 2019 309-4



In cooperation with | In Kooperation mit: - BBL LOGISTIK GmbH

Ep.	VI
	193
	E24



Q2 2026

H0 photo as placeholder | H0-Foto als Platzhalter

T0193091	DC =	- DC analogic version (1:120 TT Scale)
T0193090	=	- DC with Sound + Panto (Premium line version 1:120 TT Scale)



T 1:120

WAGÕES
FREIGHT WAGONS
GÜTERWAGEN





3 piece Zacns set | 3-tlg. Zacns Set



In cooperation with | In Kooperation mit: - BSAS EisenbahnVerkehrs GmbH & Co. KG- Feldbinder Spezialfahrzeugwerke GmbH
- M.A.D. Logistik GmbH - Erwin Kastner



Ep. VI
543



H0 photo as placeholder | H0-Foto als Platzhalter

Q4 2025

T783901 SET 3 pcs

- Set consisting of the following 3 Zacns tank wagons | Set bestehend aus den folgenden 3 Zacns Kesselwagen :
- D-BSAS 37 80 7839 202-4 "BEAR"
- D-BSAS 37 80 7839 228-9 "GRAND DANOIS"
- D-BSAS 37 80 7839 220-6 "DOLPHIN"

NEW

FREIGHT WAGONS
TT

3 piece Zacns set | 3-tlg. Zacns Set



In cooperation with | In kooperatie mit: - BSAS Eisenbahnverkehrs GmbH & Co. KG- Feldbinder Spezialfahrzeugwerke GmbH
- M.A.D. Logistik GmbH - Erwin Kastner

Erwin Kastner
M.A.D. LOGISTIK

Ep.	VI
	543



H0 photo as placeholder | H0-Foto als Platzhalter

Q4 2025

T783902 SET 3 pcs

- Set consisting of the following 3 Zacns tank wagons | Set bestehend aus den folgenden 3 Zacns Kesselwagen :
- D-BSAS 37 80 7839 995-4 "ZEBRA"
- D-BSAS 37 80 7839 208-1 "ELEPHANT"
- D-BSAS 37 80 7839 232-1 "PANTHER"



3 piece Zacns set | 3-tlg. Zacns Set



In cooperation with | In Kooperation mit: - BSAS EisenbahnVerkehrs GmbH & Co. KG- Feldbinder Spezialfahrzeugwerke GmbH
- M.A.D. Logistik GmbH - Erwin Kastner



Ep.	VI
	543



H0 photo as placeholder | H0-Foto als Platzhalter

Q4 2025

T783903 SET 3 pcs

- Set consisting of the following 3 Zacns tank wagons | Set bestehend aus den folgenden 3 Zacns Kesselwagen:
- D-BSAS 37 80 7839 206-5 "PIKE FISH"
- D-BSAS 37 80 7839 209-9 "TIGER"
- D-BSAS 37 80 7839 238-8 "GORILA"

NEW

3 piece Zacns set | 3-tlg. Zacns Set



In cooperation with | In kooperatie mit: - BSAS Eisenbahnverkehrs GmbH & Co. KG- Feldbinder Spezialfahrzeugwerke GmbH
- M.A.D. Logistik GmbH - Erwin Kastner

Ep.	VI
	543



H0 photo as placeholder | H0-Foto als Platzhalter

Q4 2025

T783904 SET 3 pcs

- Set consisting of the following 3 Zacns tank wagons | Set bestehend aus den folgenden 3 Zacns Kesselwagen :
- D-BSAS 37 80 7839 210-7 "HAWK"
- D-BSAS 37 80 7839 236-2 "LION"
- D-BSAS 37 80 7839 229-7 "RHINO"



3 piece Zacns set | 3-tlg. Zacns Set



In cooperation with | In Kooperation mit: - BSAS EisenbahnVerkehrs GmbH & Co. KG- Feldbinder Spezialfahrzeugwerke GmbH
- M.A.D. Logistik GmbH - Erwin Kastner



Ep.	VI
	543



H0 photo as placeholder | H0-Foto als Platzhalter

Q4 2025

T783905 SET 3 pcs

- Set consisting of the following 3 Zacns tank wagons | Set bestehend aus den folgenden 3 Zacns Kesselwagen :
- D-BSAS 37 80 7839 207-3 "MAD BSAS ELP"
 - D-BSAS 37 80 7839 245-3 "ZUG:KUNFT"
 - D-BSAS 37 80 7839 204-0 "ZUG:KUNFT"

Sggmrrs 90' Smart GigaWood



In cooperation with | In Kooperation mit: - Innofreight Solutions GmbH

Ep.	VI
	243



Q4 2025

H0 photo as placeholder | H0-Foto als Platzhalter

T657319

Innofreight articulated double timber transport wagon Sggmrrs | Innofreight Doppel Holztransportwagen Sggmrrs
- A-IF 35 81 4657 319-3

Sggmrrs 90' Smart GigaWood



In cooperation with | In Kooperation mit:
- Innofreight Solutions GmbH

Ep.	VI
	243



Q4 2025

H0 photo as placeholder | H0-Foto als Platzhalter

T657325

Innofreight articulated double timber transport wagon Sggmrrs | Innofreight Doppel Holztransportwagen Sggmrrs
- A-IF 35 81 4657 325-0 "500TH Smart GigaWood"

Sggmrrs 90' Smart GigaWood



In cooperation with | In Kooperation mit: - Innofreight Solutions GmbH

Ep.	VI
	243



Q4 2025

H0 photo as placeholder | H0-Foto als Platzhalter

T657010

VTG articulated double timber transport wagon Sggmrrs | VTG Doppel Holztransportwagen Sggmrrs
- D-VTG 37 80 4657 010-7



Sggmrrs 90' Smart GigaWood



In cooperation with | In Kooperation mit: - Innofreight Solutions GmbH

Ep.	VI
	243



Q4 2025

H0 photo as placeholder | H0-Foto als Platzhalter

T657095 Innofreight articulated double timber transport wagon Sggmrrs | Innofreight Doppel Holztransportwagen Sggmrrs
- A-IF 35 81 4657 095-9

Sggmrrs 90' Smart GigaWood



In cooperation with | In Kooperation mit: - Innofreight Solutions GmbH

Ep.	VI
	243



Q4 2025

H0 photo as placeholder | H0-Foto als Platzhalter

T657105 Innofreight articulated double timber transport wagon Sggmrrs | Innofreight Doppel Holztransportwagen Sggmrrs
- A-IF 35 81 4657 105-6

Sggmrrs 90' Smart GigaWood



In cooperation with | In Kooperation mit: - Innofreight Solutions GmbH

Ep.	VI
	243



Q4 2025

H0 photo as placeholder | H0-Foto als Platzhalter

T657017 VTG articulated double timber transport wagon Sggmrrs | VTG Doppel Holztransportwagen Sggmrrs
- D-VTG 37 80 4657 017-2

Sggmrrs 90' Smart GigaWood



In cooperation with | In Kooperation mit: - Innofreight Solutions GmbH

Ep.	VI
	243



Q4 2025

H0 photo as placeholder | H0-Foto als Platzhalter

T657033

VTG articulated double timber transport wagon Sggmrrs | VTG Doppel Holztransportwagen Sggmrrs
- D-VTG 37 80 4657 033-9

Sggmrrs 90' Smart GigaWood



In cooperation with | In Kooperation mit: - Innofreight Solutions GmbH

Ep.	VI
	243



Q4 2025

H0 photo as placeholder | H0-Foto als Platzhalter

T657059

VTG articulated double timber transport wagon Sggmrrs | VTG Doppel Holztransportwagen Sggmrrs
- D-VTG 37 80 4657 059-4

Sggmrrs 90' Smart GigaWood



In cooperation with | In Kooperation mit: - Innofreight Solutions GmbH

Ep.	VI
	243



Q4 2025

H0 photo as placeholder | H0-Foto als Platzhalter

T657028

VTG articulated double timber transport wagon Sggmrrs | VTG Doppel Holztransportwagen Sggmrrs
- D-VTG 37 80 4657 028-9 with SWISS KRONO AG logos | Mit SWISS KRONO AG Logos



Sggmrrs 90' Smart GigaWood



In cooperation with | In Kooperation mit: - Innofreight Solutions GmbH

Ep. VI
243



Q4 2025

H0 photo as placeholder | H0-Foto als Platzhalter

T657001 CD Cargo articulated double timber transport wagon Sggmrrs | CD Cargo Doppel Holztransportwagen Sggmrrs
- A-IF 35 81 4657 001-5

Sggmrrs 90' Smart GigaWood



In cooperation with | In Kooperation mit: - Innofreight Solutions GmbH

Ep. VI
243



Q4 2025

H0 photo as placeholder | H0-Foto als Platzhalter

T657009 CD Cargo articulated double timber transport wagon Sggmrrs | CD Cargo Doppel Holztransportwagen Sggmrrs
- A-IF 35 81 4657 009-0

Sggmrrs 90' Smart GigaWood



In cooperation with | In Kooperation mit: - Innofreight Solutions GmbH

Ep. VI
243



Q4 2025

H0 photo as placeholder | H0-Foto als Platzhalter

T657111 CD Cargo articulated double timber transport wagon Sggmrrs | CD Cargo Doppel Holztransportwagen Sggmrrs
- A-IF 35 81 4657 010-8

NEW

Sgmmrrs 90' Smart GigaWood



In cooperation with | In Kooperation mit: - Innofreight Solutions GmbH

Ep. VI

243



Q4 2025

H0 photo as placeholder | H0-Foto als Platzhalter

T657004

CD Cargo articulated double timber transport wagon Sgmmrrs | CD Cargo Doppel Holztransportwagen Sgmmrrs
- A-IF 35 81 4657 004-1



© Pedro Almeida



Contentores 20' para transporte de graneis e minério

Indicados para os nossos vagões Sgs e Sgmms.
Furação compatível com a norma NEM380.

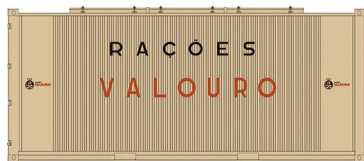

Ref.: **S6001** - Contentor 20' "RAÇÕES VALOURO", decoração anos 70

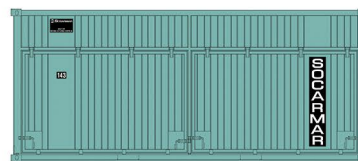

Ref.: **S6008** - contentor 20' topo aberto "SOCARMAR"

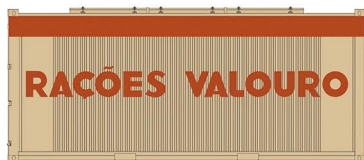

Ref.: **S6002** - Contentor 20' "RAÇÕES VALOURO", decoração anos 80



Ref.: **S6009** - contentor 20' topo aberto "SADOMAR"

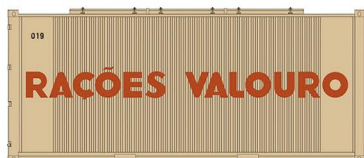

Ref.: **S6004** - Contentor 20' "RAÇÕES VALOURO", decoração anos 80



Ref.: **S6010** - contentor 20' topo aberto "SADOMAR"

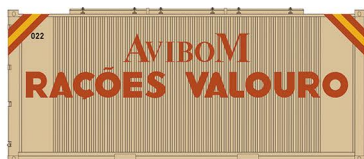

Ref.: **S6003** - Contentor 20' "AVIBOM VALOURO", decoração anos 80-90



Ref.: **S6011** - contentor 20' topo aberto "SOCARMAR"

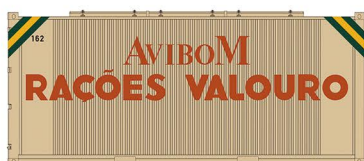

Ref.: **S6005** - Contentor 20' "AVIBOM VALOURO", decoração anos 80-90

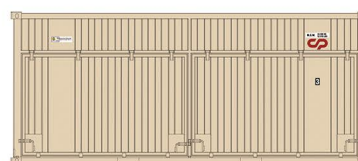

Ref.: **S6012** - contentor 20' topo aberto "SOCARMAR / CP"



Ref.: **S6006** - Contentor 20' "RAÇÕES VALOURO", decoração anos 90



Ref.: **S6013** - contentor 20' topo aberto para transporte de Petcoke

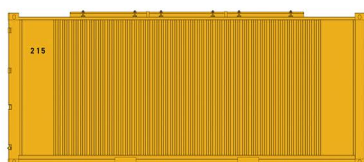

Ref.: **S6007** - Contentor 20' "RAÇÕES VALOURO", decoração anos 90-00



Intermodal swap body containers - Various standard and extra tall 45' swap bodies, ideal to use with our Laagrss and Sgss wagons. Bottom fitted with NEM380 compatible holes.



Q3 2026

S6014 45' "MICHEL VERSCHEURE TRANSPORT" swap body



Q3 2026

S6020 45' "Ekol Logistics" swap body



Q3 2026

S6015 45' "Norfolk Line" swap body



Q3 2026

S6021 45' "LKW WALTER" swap body



Q3 2026

S6016 45' "MOVE INTERMODAL" swap body



Q3 2026

S6022 45' "MARS LOGISTICS" swap body



Q3 2026

S6017 45' "Arcese" swap body



Q3 2026

S6023 45' "AMBROGIO INTERMODAL" swap body



Q3 2026

S6018 45' "Alberti e Santi" swap body



Q3 2026

S6024 45' "Nothegger" swap body



Q3 2026

S6019 45' "GTS Logistic" swap body



Q3 2026

S6025 45' "WETRON" swap body



Intermodal swap body containers - Various standard and extra tall 45' swap bodies, ideal to use with our Laagrss and Sgss
Bottom fitted with NEM380 compatib



SUDSES45 45' "Sesé" swap body



SUDTMG45 45' "Transfesa MEGA COMBI" extra tall swap body

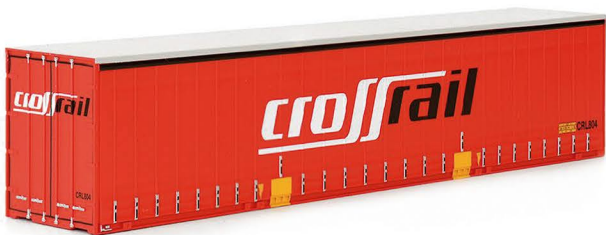

SUDCRR45 45' "Crossrail" swap body



SUDTMR45 45' "MEGA COMBI RAILMAX" extra tall swap body



SUDFER45 45' "FERCAM" swap body



SUDTRA45 45' "TRANSFESA" extra tall swap body



SUDCDG45 45' "CIMAR dark grey" swap body



SUDTOL45 45' "OMFESA" extra tall swap body



SUDCLG45 45' "CIMAR light grey" swap body



SUDDBS45 45' "DB SCHENKER" extra tall swap body



SUDMED45 45' "MEDWAY" swap body



SUDTLG45 45' "ICR" extra tall swap body

Iluminação Interior carr. Sorefame



SUD5010 DC = - Kit de iluminação interior LED, com decoder digital integrado, para todas as versões das nossas carr. CP Sorefame.

Luzes de cauda carr. Sorefame

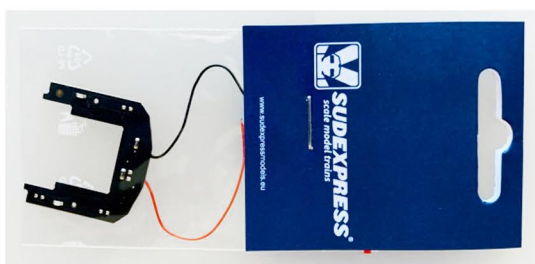

SUD5011 DC = - Kit de luzes de cauda com 2x LED vermelhos para todas as versões carr. Sorefame com topos de intercomunicação de Bourrelets.

Luzes de cauda carr. Sorefame

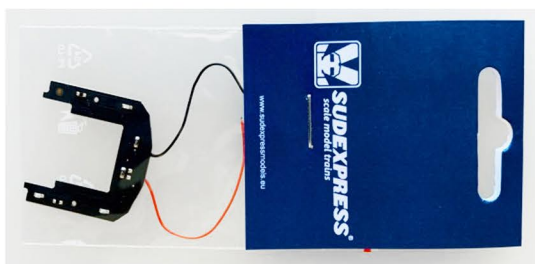

SUD5012 DC = - Kit de luzes de cauda com 3x LED vermelhos para todas as versões carr. Sorefame com topos de intercomunicação de foles e três farolins de cauda.





PowerPack Kit

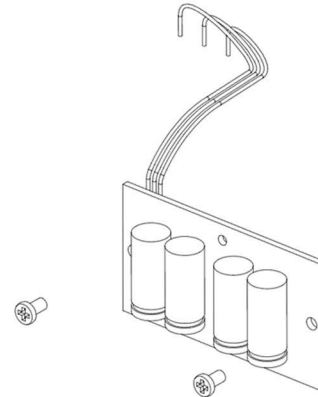

SUD3161

- PowerPack kit to retrofit in EuroDual H0 locomotives (from the second production batch - Mod. 1941H-2022 and Mod. 1941E-2022).
- PowerPack-Kit zum Nachrüsten in EuroDual H0-Loks (ab der zweiten Produktionscharge - Mod. 1941H-2022 und Mod. 1941E-2022).

PantoServo Kit

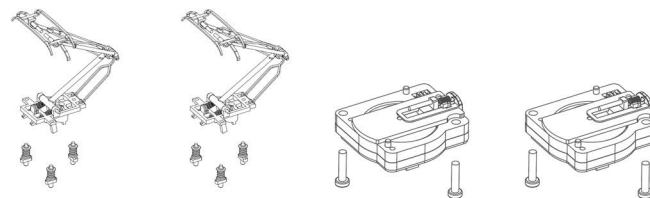

SUD3159

- Pantograph motorization kit to retrofit in EuroDual H0 locomotives. Allows for the motorization trough servo motors of both pantographs.
- Pantographen (Stromabnehmer) Motorisierungskit zum Nachrüsten in EuroDual H0-Lokomotiven. Ermöglicht die Motorisierung beider Stromabnehmer durch Servomotoren.

2 piece AC wheelset | 2-tlg. AC Radsatz

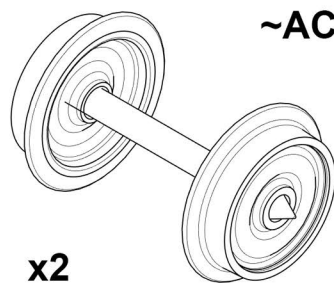

SUD2061

- 2x AC wheelsets for Sudexpress H0 Tanpps, Sggmrrs 90', Sggrrs 80' and Zacns wagons
- 2x AC-Radsätze für Sudexpress H0 Tanpps, Sggmrrs 90', Sggrrs 80' und Zacns wagen

Copyright:

© 2025 AVALIARE Engenharia Lda. All rights reserved.

® Registered trademarks: Sudexpress scale model trains, NORBRASS

Trademark owner: AVALIARE Engenharia Lda; Centro Comercial da Estação, Praça Camilo Castelo Branco 31, 2º Andar - Sala 48, 4700-209 Braga; Portugal

Liability:

Despite of our best effort and the best possible care, AVALIARE Engenharia Lda is not liable and gives no warranty for the accuracy, up-to-dateness or completeness of the contents and the information given in this catalogue.

AVALIARE Engenharia Lda reserves the right to update the contents of the catalogue as well as the technical specifications of the contained products at any time. Many models shown on the illustrations are photomontages and 3D CAD drawings. The final and delivered version of the models may therefore differ from the depicted illustrations. Electrical and mechanical data and dimensions may vary. Products from the series production may differ in detail from the depicted models. Availability and delivery options of the illustrated products are subject to change.

Haftung:

Trotz größter Bemühungen und größtmöglicher Sorgfalt übernimmt die AVALIARE Engenharia Lda keine Haftung und Gewähr für die Richtigkeit, Aktualität und Vollständigkeit der in diesem Katalog enthaltenen Inhalte und Informationen.













AVALIARE Engenharia Lda behält sich das Recht vor, den Inhalt des Katalogs sowie die technischen Spezifikationen der enthaltenen Produkte jederzeit zu aktualisieren. Viele der auf den Abbildungen gezeigten Modelle sind Fotomontagen und 3D-CAD-Zeichnungen. Die endgültige und ausgelieferte Version der Modelle kann daher von den abgebildeten Abbildungen abweichen. Elektrische und mechanische Daten und Abmessungen können abweichen. Produkte aus der Serienfertigung können im Detail von den abgebildeten Modellen abweichen. Verfügbarkeit und Liefermöglichkeiten der abgebildeten Produkte sind freibleibend.

Responsabilidade:

Apesar dos nossos melhores esforços e do maior cuidado possível, a AVALIARE Engenharia Lda não se responsabiliza e não garante a exactidão, actualização ou veracidade dos conteúdos e da informação aqui apresentada neste catálogo.

A AVALIARE Engenharia Lda reserva o direito de actualizar o conteúdo do catálogo, bem como as especificações técnicas dos produtos nele contidos a qualquer momento. Muitas das imagens presentes nas ilustrações são fotomontagens e desenhos CAD 3D. A versão final e distribuída dos modelos pode, portanto, ser diferente das ilustrações apresentadas. Dados, especificações e dimensões podem variar e diferir do indicado neste presente catálogo. A disponibilidade e a distribuição dos produtos ilustrados neste catálogo está sujeita a alterações.

Explanation of symbols | Zeichenerklärung:

Ep. III	- Epoch III: From aprox. 1945 to 1970	- Epoche III: ca. 1945 - 1970
Ep. IV	- Epoch IV: From aprox. 1965 to 1990	- Epoche IV: ca. 1965 - 1990
Ep. V	- Epoch V: From aprox. 1985 to 2010	- Epoche V: ca. 1985 - 2010
Ep. VI	- Epoch VI: Since aprox. 2005	- Epoche VI: seit 2005
 266	- Length over buffers in millimeters	- Länge über Puffer in Millimetern
	- Decoder interface of type x	- Decoder interface of type x
	- Digital controlled motorized cooling fans	- Decoderschnittstelle vom Typ x
	- Factory installed PowerPack (aka capacitor/"stay alive")	- Werkseitig installiertes PowerPack (Pufferkondensator/"Stay Alive")
	- Item number for AC suited wheelsets	- Artikelnummer für AC-geeignete Radsätze
	- Item number	- Artikelnummer
	- Item number, exclusive for x	- Artikelnummer, exklusiv für x
SET 3 pcs	- Set consisting of x pieces	- Set bestehend aus x Teilen
Q1 2025	- ETA (Estimated time of arrival): quarter x of year x	- Geschätzte Ankunftszeit: Quartal x des Jahres x
AC 	- AC digital version (Digital from factory with decoder)	- Wechselstrom digital (Digital ab Werk mit Decoder)
	- AC with Sound (Digital from factory with sound decoder)	- Wechselstrom mit Sound (Digital ab Werk mit Sounddecoder)
DC =	- DC analogic version (Digital from factory with decoder)	- Gleichstrom (Digital ab Werk mit Decoder)
= 	- DC with Sound (Digital from factory with sound decoder)	- Gleichstrom mit Sound (Digital ab Werk mit Sounddecoder)
	- Digital controlled couplers	- Digital gesteuerte Kupplung
	- Digital controlled pantographs	- Digital gesteuerte Stromabnehmer



Avaliare Eng. Lda.

Centro Comercial da Estação
Praça Camilo Castelo Branco, 31
2º andar - Sala 48
4700 - 209 Braga
Portugal



www.sudexpressmodels.eu



follow us on social media

Your official Sudexpress reseller

Fev. 2025 edit. € 5,00

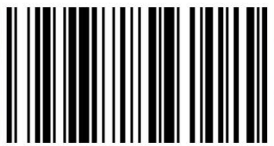

S1009